

**ARM<sup>®</sup> Cortex<sup>®</sup>-M  
32-bit Microcontroller**

**NuMaker-M032KI  
User Manual  
NuMicro<sup>®</sup> M032 Series**

*The information described in this document is the exclusive intellectual property of Nuvoton Technology Corporation and shall not be reproduced without permission from Nuvoton.*

*Nuvoton is providing this document only for reference purposes of NuMicro microcontroller based system design. Nuvoton assumes no responsibility for errors or omissions.*

*All data and specifications are subject to change without notice.*

For additional information or questions, please contact: Nuvoton Technology Corporation.

[www.nuvoton.com](http://www.nuvoton.com)

**Table of Contents**

1 Overview ..... 7

    1.1 NuMaker-M032KI Features ..... 7

2 NuMaker-M032KI Overview ..... 9

    2.1 Front View ..... 9

    2.2 Rear View ..... 10

    2.3 Arduino UNO Compatible Extension Connectors ..... 11

    2.4 Pin Assignment for Extension Connectors ..... 13

    2.5 System Configuration ..... 18

        2.5.1 VIN Power Source ..... 18

        2.5.2 5 V Power Sources ..... 18

        2.5.3 3.3 V Power Sources ..... 18

        2.5.4 1.8V Power Sources ..... 19

        2.5.5 Power Connectors ..... 19

        2.5.6 USB Connectors ..... 19

        2.5.7 Power Switches ..... 19

        2.5.8 Power Supply Models ..... 20

        2.5.9 External Reference Voltage Connector ..... 23

        2.5.10 Ammeter Connector ..... 23

        2.5.11 Extension Connectors ..... 23

        2.5.12 Push-Buttons ..... 24

        2.5.13 LEDs ..... 24

    2.6 Nu-Link2-Me ..... 24

    2.7 PCB Placement ..... 25

3 Quick Start ..... 26

    3.1 Toolchains Supporting ..... 26

    3.2 Nuvoton Nu-Link Driver Installation ..... 26

    3.3 BSP Firmware Download ..... 28

    3.4 Hardware Setup ..... 28

    3.5 Find the Example Project ..... 30

    3.6 Execute the Project under Toolchains ..... 30

        3.6.1 Keil MDK ..... 30

        3.6.2 IAR EWARM ..... 34

        3.6.3 NuEclipse ..... 36

4 NuMaker-M032KI Schematics ..... 43

4.1 Nu-Link2-Me .....43

4.2 M032 platform .....44

4.3 Extension Connector .....45

5 REVISION HISTORY ..... 46

**List of Figures**

Figure 1-1 NuMaker-M032KI Board ..... 7

Figure 2-1 Front View of NuMaker-M032KI ..... 9

Figure 2-2 Rear View of NuMaker-M032KI ..... 10

Figure 2-3 Arduino UNO Compatible Extension Connectors ..... 11

Figure 2-4 M032KIAAE Extension Connectors ..... 13

Figure 2-5 External Power Supply Sources on Nu-Link2-Me ..... 20

Figure 2-6 External Power Supply Sources on M032 platform ..... 21

Figure 2-7 Separate the Nu-Link2-Me from NuMaker-M032KI ..... 22

Figure 2-8 Wiring between Ammeter Connector and Ammeter ..... 23

Figure 2-9 Front Placement ..... 25

Figure 2-10 Rear Placement ..... 25

Figure 3-1 Nu-Link USB Driver Installation Setup ..... 26

Figure 3-2 Nu-Link USB Driver Installation ..... 27

Figure 3-3 Open VCOM Function ..... 28

Figure 3-4 ICE USB Connector ..... 28

Figure 3-5 Device Manger ..... 29

Figure 3-6 PuTTY Session Setting ..... 29

Figure 3-7 Template Project Folder Path ..... 30

Figure 3-8 Warning Message of “Device not found” ..... 30

Figure 3-9 Project File Migrate to Version 5 Format ..... 31

Figure 3-10 Debugger Setting in Options Window ..... 31

Figure 3-11 Programming Setting in Options Window ..... 32

Figure 3-12 Compile and Download the Project ..... 32

Figure 3-13 Keil MDK Debug Mode ..... 33

Figure 3-14 Debug Message on Serial Port Terminal Windows ..... 33

Figure 3-15 IAR EWARM Window ..... 34

Figure 3-16 Compile and Download the Project ..... 34

Figure 3-17 IAR EWARM Debug Mode ..... 35

Figure 3-18 Debug Message on Serial Port Terminal Windows ..... 35

Figure 3-19 Import the Project in NuEclipse ..... 36

Figure 3-20 Import Projects Windows ..... 37

Figure 3-21 Open Project Properties Window ..... 37

Figure 3-22 Project Properties Settings ..... 38

Figure 3-23 Build Project ..... 38

Figure 3-24 Open Debug Configuration ..... 39

Figure 3-25 Main Tab Configuration ..... 40

Figure 3-26 Debugger Tab Configuration ..... 40

Figure 3-27 Startup Tab Configuration ..... 41

Figure 3-28 NuEclipse Debug Mode ..... 42

Figure 3-29 Debug Message on Serial Port Terminal Windows ..... 42

Figure 4-1 Nu-Link2-Me Circuit ..... 43

Figure 4-2 M032 platform Circuit ..... 44

Figure 4-3 Extension Connectors Circuit ..... 45

**List of Tables**

Table 2-1 Arduino UNO Extension Connectors and M032KIAAE Mapping GPIO List..... 12

Table 2-2 M032KIAAE Full-pin Extension Connectors and GPIO Function List ..... 17

Table 2-3 Vin Power Source ..... 18

Table 2-4 5V Power Sources ..... 18

Table 2-5 3.3 V Power Sources ..... 18

Table 2-6 1.8V Power Sources ..... 19

Table 2-7 Power Connectors ..... 19

Table 2-8 USB Connectors ..... 19

Table 2-9 Power Switches ..... 19

Table 2-10 Supply External Power through Nu-Link2-Me ..... 20

Table 2-11 Supply External Power for M032 platform ..... 22

Table 2-12 External Reference Voltage Connector ..... 23

Table 2-13 Ammeter Connector..... 23

Table 2-14 Extension Connectors..... 23

Table 2-15 Push-Buttons ..... 24

Table 2-16 LEDs ..... 24

Table 2-17 VCOM Function of Nu-Link2-Me..... 24

## 1 OVERVIEW

This user manual is aimed to give users a fast introduction to the use of NuMaker-M032KI board.

The NuMaker-M032KI consists of two parts, a M032 platform and an on-board Nu-Link2-Me debugger and programmer. The NuMaker-M032KI allows users to quickly develop and easily program and debug application.

The NuMaker-M032KI offers M032KIAAE full pins extension connectors, Arduino UNO compatible extension connectors and diversified power supply option. It is an easy-to-develop platform for user to expand the functionality and build the applications. The NuMaker-M032KI also provides an ammeter connector, allows user to monitor the microcontroller's power consumption during development.

The Nu-Link2-Me is a debugger and programmer that supports on-line programming and debugging through SWD interface. The on-board 16 Mbit SPI Flash allows it able to off-line programming the target microcontroller. Nu-Link2-Me provides virtual COM port (VCOM) function to print out messages on PC. Nu-Link2-Me can be separated from NuMaker-M032KI, allowing user to use as a mass production programming tool.

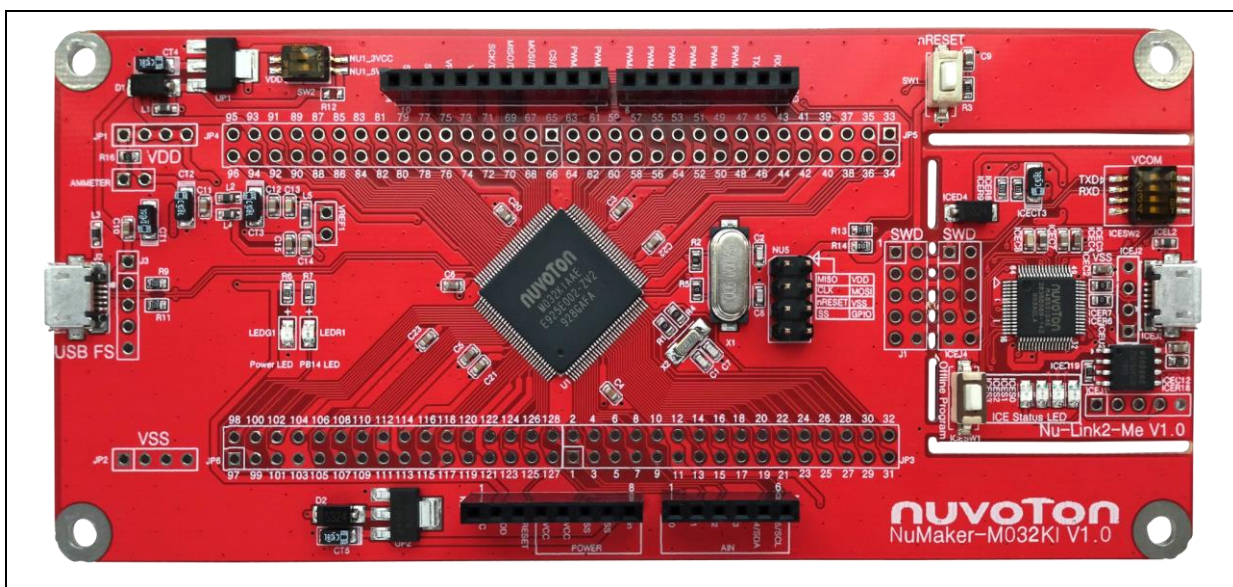

Figure 1-1 NuMaker-M032KI Board

### 1.1 NuMaker-M032KI Features

- NuMicro® NUMAKER-M032KI used as main microcontroller with function downward compatible with:
  - ◆ M032KIAAE
  - ◆ M032SIAAE
- M032KIAAE full pins extension connectors
- Arduino UNO compatible extension connectors
- Ammeter connector for measuring the microcontroller's power consumption
- Fixable board power supply:
  - ◆ External  $V_{DD}$  power connector
  - ◆ Arduino UNO compatible extension connector  $V_{in}$
  - ◆ USB FS connector on M032 platform

- ◆ ICE USB connector on Nu-Link2-Me
- On-board Nu-Link2-Me debugger and programmer:
  - ◆ Debug through SWD interface
  - ◆ On-line/off-line programming
  - ◆ Virtual COM port function



## 2 NUMAKER-M032KI OVERVIEW

### 2.1 Front View

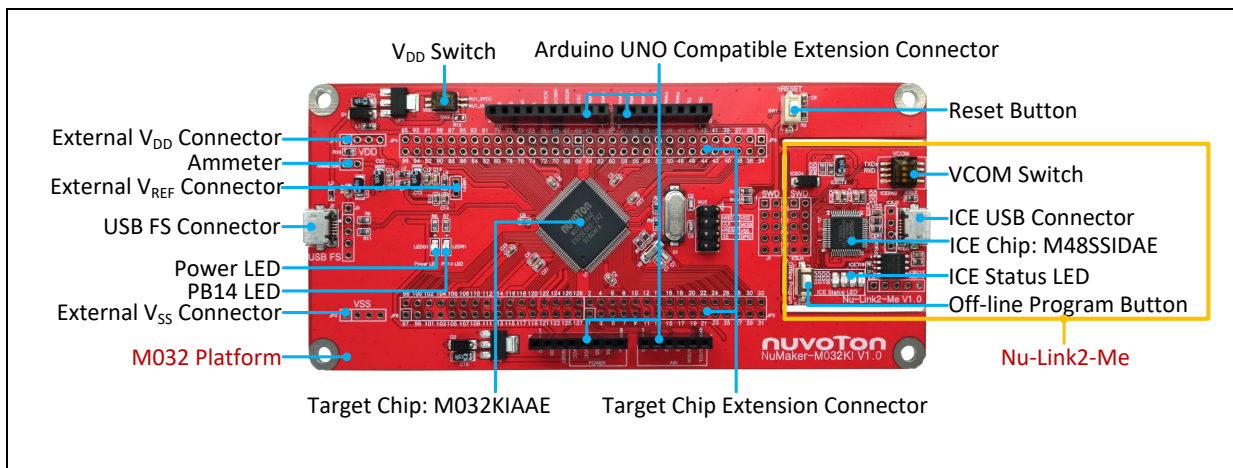

Figure 2-1 Front View of NuMaker-M032KI

Figure 2-1 shows the main components and connectors from the front side of NuMaker-M032KI. The following lists components and connectors from the front view:

- Target Chip: M032KIAAE(U1)
- USB FS Connector(J2)
- Arduino UNO Compatible Extension Connectors (NU1, NU2, NU3, NU4)
- M032 Extension Connectors (JP3, JP4, JP5 and JP6)
- External  $V_{DD}$  Power Connector(JP1)
- External  $V_{SS}$  Power Connector(JP2)
- External  $V_{REF}$  Connector(VREF1)
- VDD Switch(SW2)
- Ammeter Connector(AMMETER)
- Reset Button(SW1)
- Power LED and PB14 LED(LEDG1 and LEDR1)
- Nu-Link2-Me
  - ◆ VCOM Switch
  - ◆ ICE Chip: M48SSIDAE(ICEU2)
  - ◆ ICE USB Connector(ICEJ3)
  - ◆ ICE Status LED(ICES0,ICES1, ICES2, ICES3)
  - ◆ Off-line Program Button(ICESW1)

## 2.2 Rear View

Figure 2-2 shows the main components and connectors from the rear side of NuMaker-M032KI.

The following lists components and connectors from the rear view:

- Nu-Link2-Me
- ◆ MCUVCC Power Switch (ICEJPR1)
- ◆ ICEVCC Power Switch (ICEJPR2)

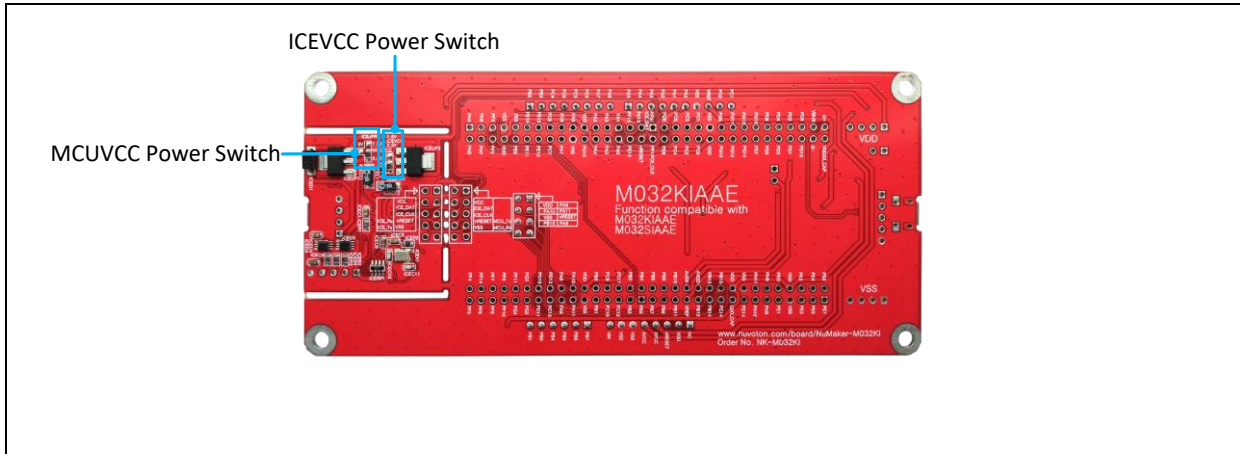

Figure 2-2 Rear View of NuMaker-M032KI

### 2.3 Arduino UNO Compatible Extension Connectors

Figure 2-3 shows the Arduino UNO compatible extension connectors.

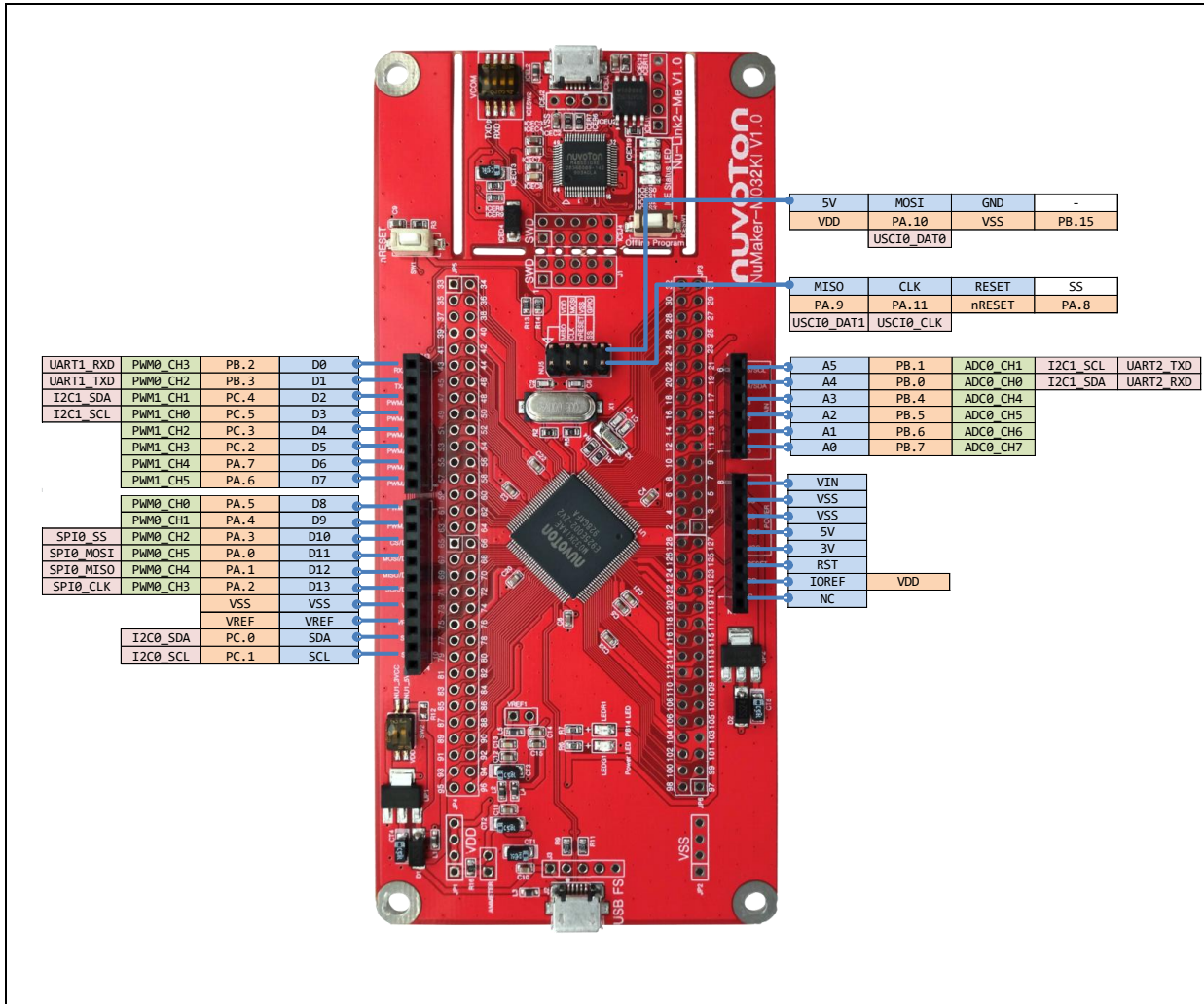

Figure 2-3 Arduino UNO Compatible Extension Connectors

Header		NuMaker-M032KI		Header		NuMaker-M032KI	
		Compatible to Arduino UNO	GPIO Pin of M032			Compatible to Arduino UNO	GPIO Pin of M032
N U 4	NU3.1	D0	PB.2	N U 2	NU2.6	A5	PB.1
	NU3.2	D1	PB.3		NU2.5	A4	PB.0
	NU3.3	D2	PC.4		NU2.4	A3	PB.4
	NU3.4	D3	PC.5		NU2.3	A2	PB.5
	NU3.5	D4	PC.3		NU2.2	A1	PB.6
	NU3.6	D5	PC.2		NU2.1	A0	PB.7
	NU3.7	D6	PA.7	N U 1	NU1.8	VIN	-
	NU3.8	D7	PA.6		NU1.7	VSS	
N U 3	NU4.1	D8	PA.5		NU1.6	VSS	
	NU4.2	D9	PA.4		NU1.5	5V	
	NU4.3	D10	PA.3		NU1.4	3V	
	NU4.4	D11	PA.0		NU1.3	RST	nRESET
	NU4.5	D12	PA.1		NU1.2	IOREF	V <sub>REF</sub>
	NU4.6	D13	PA.2	NU1.1	NC	-	
	NU4.7	VSS	V <sub>SS</sub>				
	NU4.8	VREF	V <sub>REF</sub>				
	NU4.9	SDA	PC.0				
	NU4.10	SCL	PC.1				

Table 2-1 Arduino UNO Extension Connectors and M032KIAAE Mapping GPIO List

## 2.4 Pin Assignment for Extension Connectors

The NuMaker-M032KI provides the M032KIAAE target chip onboard and full pins extension connectors (JP3, JP4, JP5 and JP6). The Figure 2-4 shows the M032KIAAE extension connectors.

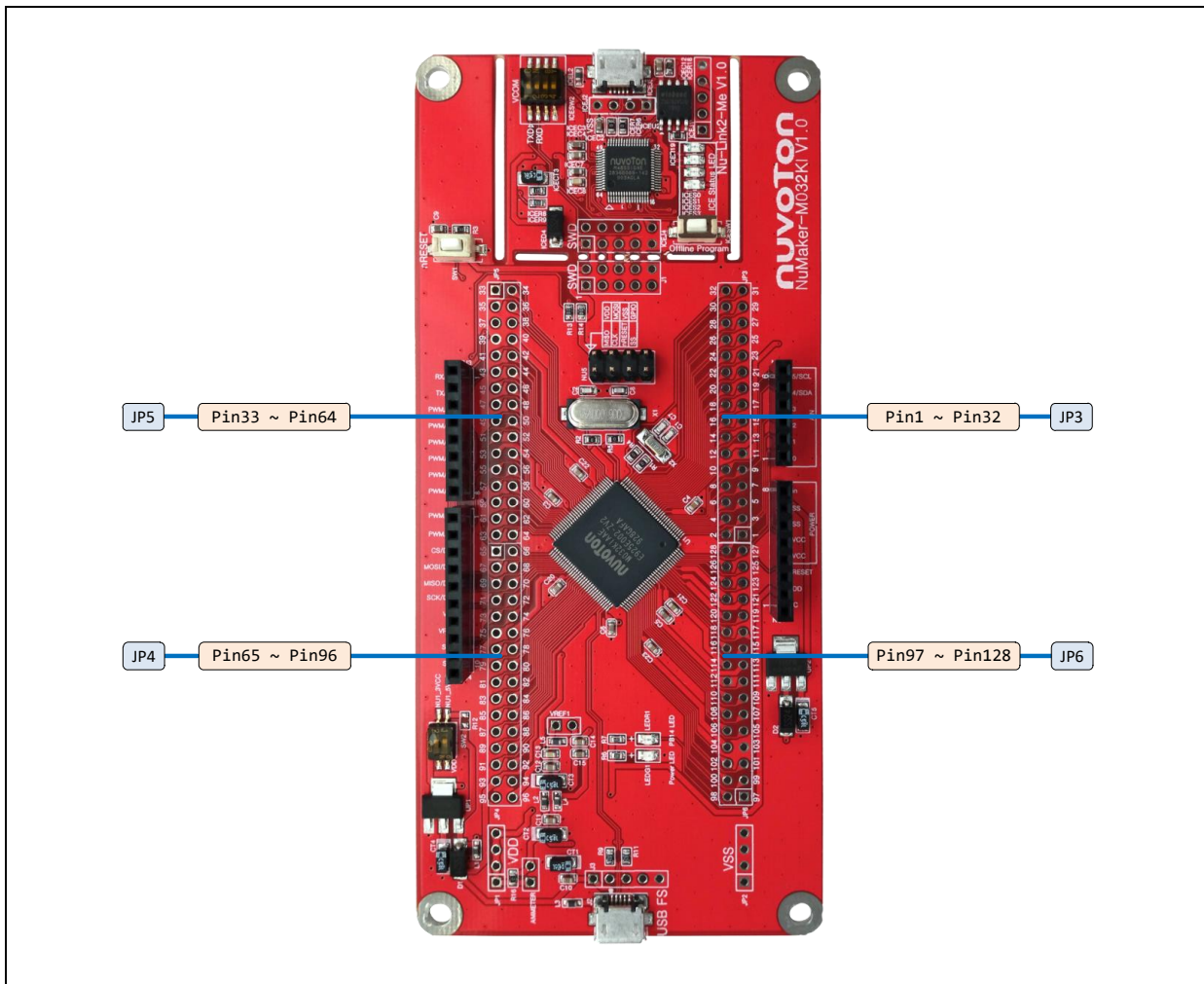

Figure 2-4 M032KIAAE Extension Connectors

Header		M032KIAAE	
		Pin No.	Function
JP3	JP3.1	1	PB.5/ADC0_CH5/ACMP1_N/EBI_ADR0/I2C0_SCL/UART5_TXD/USCI1_CTL0/PWM0_CH0/UART2_TXD/TM0/INT0
	JP3.2	2	PB.4/ADC0_CH4/ACMP1_P1/EBI_ADR1/I2C0_SDA/UART5_RXD/USCI1_CTL1/PWM0_CH1/UART2_RXD/TM1/INT1
	JP3.3	3	PB.3/ADC0_CH3/ACMP0_N/EBI_ADR2/I2C1_SCL/UART1_TXD/UART5_nRTS/USCI1_DAT1/PWM0_CH2/PWM0_BRAKE0/TM2/INT2
	JP3.4	4	PB.2/ADC0_CH2/ACMP0_P1/EBI_ADR3/I2C1_SDA/UART1_RXD/UART5_nCTS/USCI1_DAT0/PWM0_CH3/TM3/INT3
	JP3.5	5	PC.12/EBI_ADR4/UART0_TXD/I2C0_SCL/UART6_TXD/PWM1_CH0/ACMP0_O
	JP3.6	6	PC.11/EBI_ADR5/UART0_RXD/I2C0_SDA/UART6_RXD/PWM1_CH1/ACMP1_O
	JP3.7	7	PC.10/EBI_ADR6/UART6_nRTS/UART3_TXD/PWM1_CH2
	JP3.8	8	PC.9/EBI_ADR7/UART6_nCTS/UART3_RXD/PWM1_CH3
	JP3.9	9	PB.1/ADC0_CH1/EBI_ADR8/UART2_TXD/USCI1_CLK/I2C1_SCL/QSPI0_MISO1/PWM0_CH4/PWM1_CH4/PWM0_BRAKE0
	JP3.10	10	PB.0/ADC0_CH0/EBI_ADR9/UART2_RXD/SPI0_I2SMCLK/I2C1_SDA/QSPI0_MOS1/PWM0_CH5/PWM1_CH5/PWM0_BRAKE1
	JP3.11	11	VSS
	JP3.12	12	VDD
	JP3.13	13	PA.11/ACMP0_P0/EBI_nRD/USCI0_CLK/UART6_TXD/BPWM0_CH0/TM0_EXT
	JP3.14	14	PA.10/ACMP1_P0/EBI_nWR/USCI0_DAT0/UART6_RXD/BPWM0_CH1/TM1_EXT
	JP3.15	15	PA.9/EBI_MCLK/USCI0_DAT1/UART1_TXD/UART7_TXD/BPWM0_CH2/TM2_EXT
	JP3.16	16	PA.8/EBI_ALE/USCI0_CTL1/UART1_RXD/UART7_RXD/BPWM0_CH3/TM3_EXT/INT4
	JP3.17	17	PC.13/EBI_ADR10/USCI0_CTL0/UART2_TXD/BPWM0_CH4/CLKO/ADC0_ST
	JP3.18	18	PD.12/EBI_nCS0/UART2_RXD/BPWM0_CH5/CLKO/ADC0_ST/INT5
	JP3.19	19	PD.11/EBI_nCS1/UART1_TXD
	JP3.20	20	PD.10/UART1_RXD
	JP3.21	21	PG.2/EBI_ADR11/I2C0_SMBAL/I2C1_SCL/TM0
	JP3.22	22	PG.3/EBI_ADR12/I2C0_SMBUS/I2C1_SDA/TM1
	JP3.23	23	PG.4/EBI_ADR13/TM2
	JP3.24	24	PF.11/EBI_ADR14/UART5_TXD/TM3
	JP3.25	25	PF.10/EBI_ADR15/SPI0_I2SMCLK/UART5_RXD
	JP3.26	26	PF.9/EBI_ADR16/SPI0_SS/UART5_nRTS
	JP3.27	27	PF.8/EBI_ADR17/SPI0_CLK/UART5_nCTS
	JP3.28	28	PF.7/EBI_ADR18/SPI0_MISO/UART4_TXD
	JP3.29	29	PF.6/EBI_ADR19/SPI0_MOSI/UART4_RXD/EBI_nCS0
	JP3.30	30	PF.14/PWM1_BRAKE0/PWM0_BRAKE0/PWM0_CH4/CLKO/TM3/INT5
	JP3.31	31	PF.5/UART2_RXD/UART2_nCTS/PWM0_CH0/BPWM0_CH4/X32_IN/ADC0_ST
	JP3.32	32	PF.4/UART2_TXD/UART2_nRTS/PWM0_CH1/BPWM0_CH5/X32_OUT
JP5	JP5.1	33	PH.4/EBI_ADR3/UART7_nRTS/UART6_TXD



Header	M032KIAAE		
	Pin No.	Function	
	JP5.2	34	PH.5/EBI_ADR2/UART7_nCTS/UART6_RXD
	JP5.3	35	PH.6/EBI_ADR1/UART7_TXD
	JP5.4	36	PH.7/EBI_ADR0/UART7_RXD
	JP5.5	37	PF.3/EBI_nCS0/UART0_TXD/I2C0_SCL/XT1_IN/BPWM1_CH0
	JP5.6	38	PF.2/EBI_nCS1/UART0_RXD/I2C0_SDA/QSPI0_CLK/XT1_OUT/BPWM1_CH1
	JP5.7	39	VSS
	JP5.8	40	VDD
	JP5.9	41	PE.8/EBI_ADR10/USCI1_CTL1/UART2_TXD/PWM0_CH0/PWM0_BRAKE0
	JP5.10	42	PE.9/EBI_ADR11/USCI1_CTL0/UART2_RXD/PWM0_CH1/PWM0_BRAKE1
	JP5.11	43	PE.10/EBI_ADR12/USCI1_DAT0/UART3_TXD/PWM0_CH2/PWM1_BRAKE0
	JP5.12	44	PE.11/EBI_ADR13/USCI1_DAT1/UART3_RXD/UART1_nCTS/PWM0_CH3/PWM1_BRAKE1
	JP5.13	45	PE.12/EBI_ADR14/USCI1_CLK/UART1_nRTS/PWM0_CH4
	JP5.14	46	PE.13/EBI_ADR15/I2C0_SCL/UART4_nRTS/UART1_TXD/PWM0_CH5/PWM1_CH0/BPWM1_CH5
	JP5.15	47	PC.8/EBI_ADR16/I2C0_SDA/UART4_nCTS/UART1_RXD/PWM1_CH1/BPWM1_CH4
	JP5.16	48	PC.7/EBI_AD9/UART4_TXD/UART0_nCTS/UART6_TXD/PWM1_CH2/BPWM1_CH0/TM0/INT3
	JP5.17	49	PC.6/EBI_AD8/UART4_RXD/UART0_nRTS/UART6_RXD/PWM1_CH3/BPWM1_CH1/TM1/INT2
	JP5.18	50	PA.7/EBI_AD7/UART0_TXD/I2C1_SCL/PWM1_CH4/BPWM1_CH2/ACMP0_WLAT/TM2/INT1
	JP5.19	51	PA.6/EBI_AD6/UART0_RXD/I2C1_SDA/PWM1_CH5/BPWM1_CH3/ACMP1_WLAT/TM3/INT0
	JP5.20	52	VSS
	JP5.21	53	VDD
	JP5.22	54	PD.15/PWM0_CH5/TM3/INT1
	JP5.23	55	PA.5/QSPI0_MISO1/UART0_nCTS/UART0_TXD/I2C0_SCL/UART5_TXD/BPWM0_CH5/PWM0_CH0
	JP5.24	56	PA.4/QSPI0_MOSI1/SPI0_I2SMCLK/UART0_nRTS/UART0_RXD/I2C0_SDA/UART5_RXD/BPWM0_CH4/PWM0_CH1
	JP5.25	57	PA.3/QSPI0_SS/SPI0_SS/UART4_TXD/I2C0_SMBAL/UART1_TXD/I2C1_SCL/BPWM0_CH3/PWM0_CH2/CLKO/PWM1_BRAKE1
	JP5.26	58	PA.2/QSPI0_CLK/SPI0_CLK/UART4_RXD/I2C0_SMBUS/UART1_RXD/I2C1_SDA/BPWM0_CH2/PWM0_CH3
	JP5.27	59	PA.1/QSPI0_MISO0/SPI0_MISO/UART0_TXD/UART1_nCTS/BPWM0_CH1/PWM0_CH4
	JP5.28	60	PA.0/QSPI0_MOSI0/SPI0_MOSI/UART0_RXD/UART1_nRTS/BPWM0_CH0/PWM0_CH5
	JP5.29	61	PF.15/PWM0_BRAKE0/PWM0_CH1/TM2/CLKO/INT4
	JP5.30	62	PE.14/EBI_AD8/UART2_TXD/UART6_TXD
	JP5.31	63	PE.15/EBI_AD9/UART2_RXD/UART6_RXD
	JP5.32	64	nRESET
JP4	JP4.1	65	PF.0/UART1_TXD/I2C1_SCL/UART0_TXD/BPWM1_CH0/ICE_DAT
	JP4.2	66	PF.1/UART1_RXD/I2C1_SDA/UART0_RXD/BPWM1_CH1/ICE_CLK
	JP4.3	67	PD.9/EBI_AD7/UART2_nCTS/UART7_TXD

Header	M032KIAAE			
	Pin No.	Function		
JP4	JP4.4	68	PD.8/EBI_AD6/UART2_nRTS/UART7_RXD	
	JP4.5	69	PC.5/EBI_AD5/QSPI0_MISO1/UART2_TXD/I2C1_SCL/UART4_TXD/PWM1_CH0	
	JP4.6	70	PC.4/EBI_AD4/QSPI0_MOSI1/UART2_RXD/I2C1_SDA/UART4_RXD/PWM1_CH1	
	JP4.7	71	PC.3/EBI_AD3/QSPI0_SS/UART2_nRTS/I2C0_SMBAL/UART3_TXD/PWM1_CH2	
	JP4.8	72	PC.2/EBI_AD2/QSPI0_CLK/UART2_nCTS/I2C0_SMBSUS/UART3_RXD/PWM1_CH3	
	JP4.9	73	PC.1/EBI_AD1/QSPI0_MISO0/UART2_TXD/I2C0_SCL/PWM1_CH4/ACMP0_O/ADC0_ST	
	JP4.10	74	PC.0/EBI_AD0/QSPI0_MOSI0/UART2_RXD/I2C0_SDA/PWM1_CH5/ACMP1_O	
	JP4.11	75	VSS	
	JP4.12	76	VDD	
	JP4.13	77	PG.9/EBI_AD0/BPWM0_CH5	
	JP4.14	78	PG.10/EBI_AD1/BPWM0_CH4	
	JP4.15	79	PG.11/EBI_AD2/UART7_TXD/BPWM0_CH3	
	JP4.16	80	PG.12/EBI_AD3/UART7_RXD/BPWM0_CH2	
	JP4.17	81	PG.13/EBI_AD4/UART6_TXD/BPWM0_CH1	
	JP4.18	82	PG.14/EBI_AD5/UART6_RXD/BPWM0_CH0	
	JP4.19	83	PG.15/CLKO/ADC0_ST	
	JP4.20	84	PD.7/UART1_TXD/I2C0_SCL/USCI1_CLK	
	JP4.21	85	PD.6/UART1_RXD/I2C0_SDA/USCI1_DAT1	
	JP4.22	86	PD.5/I2C1_SCL/USCI1_DAT0	
	JP4.23	87	PD.4/USCI0_CTL0/I2C1_SDA/USCI1_CTL1	
	JP4.24	88	PD.3/EBI_AD10/USCI0_CTL1/SPI0_SS/UART3_nRTS/USCI1_CTL0/UART0_TXD	
	JP4.25	89	PD.2/EBI_AD11/USCI0_DAT1/SPI0_CLK/UART3_nCTS/UART0_RXD	
	JP4.26	90	PD.1/EBI_AD12/USCI0_DAT0/SPI0_MISO/UART3_TXD	
	JP4.27	91	PD.0/EBI_AD13/USCI0_CLK/SPI0_MOSI/UART3_RXD/TM2	
	JP4.28	92	PD.13/EBI_AD10/SPI0_I2SMCLK	
	JP4.29	93	PA.12/UART4_TXD/I2C1_SCL/BPWM1_CH2	
	JP4.30	94	PA.13/UART4_RXD/I2C1_SDA/BPWM1_CH3	
	JP4.31	95	PA.14/UART0_TXD/BPWM1_CH4	
	JP4.32	96	PA.15/UART0_RXD/BPWM1_CH5	
	JP6	JP6.1	97	PE.7/UART5_TXD/PWM0_CH0/BPWM0_CH5
		JP6.2	98	PE.6/USCI0_CTL0/UART5_RXD/PWM0_CH1/BPWM0_CH4
		JP6.3	99	PE.5/EBI_nRD/USCI0_CTL1/UART6_TXD/UART7_nRTS/PWM0_CH2/BPWM0_CH3
JP6.4		100	PE.4/EBI_nWR/USCI0_DAT1/UART6_RXD/UART7_nCTS/PWM0_CH3/BPWM0_CH2	
JP6.5		101	PE.3/EBI_MCLK/USCI0_DAT0/UART6_nRTS/UART7_TXD/PWM0_CH4/BPWM0_CH1	
JP6.6		102	PE.2/EBI_ALE/USCI0_CLK/UART6_nCTS/UART7_RXD/PWM0_CH5/BPWM0_CH0	



Header	M032KIAAE	
	Pin No.	Function
JP6.7	103	VSS
JP6.8	104	VDD
JP6.9	105	PE.1/EBI_AD10/QSPI0_MISO0/UART3_TXD/I2C1_SCL/UART4_nCTS
JP6.10	106	PE.0/EBI_AD11/QSPI0_MOSI0/UART3_RXD/I2C1_SDA/UART4_nRTS
JP6.11	107	PH.8/EBI_AD12/QSPI0_CLK/UART3_nRTS/UART1_TXD
JP6.12	108	PH.9/EBI_AD13/QSPI0_SS/UART3_nCTS/UART1_RXD
JP6.13	109	PH.10/EBI_AD14/QSPI0_MISO1/UART4_TXD/UART0_TXD
JP6.14	110	PH.11/EBI_AD15/QSPI0_MOSI1/UART4_RXD/UART0_RXD/PWM0_CH5
JP6.15	111	PD.14/EBI_nCS0/SPI0_I2SMCLK/USCI0_CTL0/PWM0_CH4
JP6.16	112	VSS
JP6.17	113	LDO_CAP
JP6.18	114	VDD
JP6.19	115	PC.14/EBI_AD11/SPI0_I2SMCLK/USCI0_CTL0/QSPI0_CLK/TM1
JP6.20	116	PB.15/ADC0_CH15/EBI_AD12/SPI0_SS/USCI0_CTL1/UART0_nCTS/UART3_TXD/PWM1_CH0/TM0_EXT/PWM0_BRAKE1
JP6.21	117	PB.14/ADC0_CH14/EBI_AD13/SPI0_CLK/USCI0_DAT1/UART0_nRTS/UART3_RXD/PWM1_CH1/TM1_EXT/CLKO
JP6.22	118	PB.13/ADC0_CH13/ACMP0_P3/ACMP1_P3/EBI_AD14/SPI0_MISO/USCI0_DAT0/UART0_TXD/UART3_nRTS/PWM1_CH2/TM2_EXT
JP6.23	119	PB.12/ADC0_CH12/ACMP0_P2/ACMP1_P2/EBI_AD15/SPI0_MOSI/USCI0_CLK/UART0_RXD/UART3_nCTS/PWM1_CH3/TM3_EXT
JP6.24	120	AVDD
JP6.25	121	VREF
JP6.26	122	AVSS
JP6.27	123	PB.11/ADC0_CH11/EBI_ADR16/UART0_nCTS/UART4_TXD/I2C1_SCL/SPI0_I2SMCLK/BPWM1_CH0
JP6.28	124	PB.10/ADC0_CH10/EBI_ADR17/USCI1_CTL0/UART0_nRTS/UART4_RXD/I2C1_SDA/BPWM1_CH1
JP6.29	125	PB.9/ADC0_CH9/EBI_ADR18/USCI1_CTL1/UART0_TXD/UART1_nCTS/UART7_TXD/BPWM1_CH2
JP6.30	126	PB.8/ADC0_CH8/EBI_ADR19/USCI1_CLK/UART0_RXD/UART1_nRTS/UART7_RXD/BPWM1_CH3
JP6.31	127	PB.7/ADC0_CH7/EBI_nWRL/USCI1_DAT0/UART1_TXD/EBI_nCS0/BPWM1_CH4/PWM1_BRAKE0/PWM1_CH4/INT5/ACMP0_O
JP6.32	128	PB.6/ADC0_CH6/EBI_nWRH/USCI1_DAT1/UART1_RXD/EBI_nCS1/BPWM1_CH5/PWM1_BRAKE1/PWM1_CH5/INT4/ACMP1_O

Table 2-2 M032KIAAE Full-pin Extension Connectors and GPIO Function List

## 2.5 System Configuration

### 2.5.1 VIN Power Source

Table 2-3 presents the Vin power source.

Connector	Net Name in Schematic	Comment
NU1 pin8	NU1_VIN	Board external power source, with voltage range from 7 V to 12 V. The voltage regulator UP2 converts the NU1 pin8 input voltage to 5 V and supplies it to NuMaker-M032KI.

Table 2-3 Vin Power Source

### 2.5.2 5 V Power Sources

Table 2-4 presents the 5 V power sources.

Connector	Net Name in Schematic	Comment
ICEJ3	USB_HS_VBUS	ICE USB connector supplies 5 V power from PC to M032 platform and Nu-Link2-Me.
J2	USB_VBUS	USB connector on NuMaker-M032KI supplies 5 V power from PC to M032 platform and Nu-Link2-Me.
NU1 pin5	NU1_5VCC	ICEJ3, J2 or NU1 pin8 supplies 5 V power to NU1 pin5. NU1 pin5 supplies 5 V power to target chip or Arduino adapter board. <b>Note:</b> M032 operating voltage range is from 1.8 V to 3.6 V. Do not switch SW2.1(NU1 5VCC) to ON.

Table 2-4 5V Power Sources

### 2.5.3 3.3 V Power Sources

Table 2-5 presents the 3.3 V power sources.

Voltage Regulator	5V Source	Comment
ICEUP1	USB_HS_VBUS	ICEUP1 converts USB_HS_VBUS to 3.3 V and supplies 3.3V to M032 platform or ICE chip.
UP1	USB_VBUS	UP1 converts USB_VBUS to 3.3 V and supplies 3.3 V to M032 platform. <b>Note:</b> SW2.2(NU1 3VCC) should be switched to ON.
UP1	NU1_5VCC	UP1 converts NU1_5VCC to 3.3 V and supplies 3.3 V to M032 platform. <b>Note:</b> SW2.2(NU1 3VCC) should be switched to ON.

Table 2-5 3.3 V Power Sources

### 2.5.4 1.8V Power Sources

Table 2-6 presents the 1.8 V power source.

Voltage Regular	5V Source	Comment
ICEUP2	USB_HS_VBUS	ICEUP2 converts USB_HS_VBUS to 1.8V and supplies 1.8V to M032 platform or ICE chip.

Table 2-6 1.8V Power Sources

### 2.5.5 Power Connectors

Table 2-7 presents the power connectors.

Connector	Comment
JP1	V <sub>DD</sub> (1.8 V ~ 3.6 V) connector on the NuMaker-M032KI.
JP2	V <sub>SS</sub> connector on the NuMaker-M032KI.

Table 2-7 Power Connectors

### 2.5.6 USB Connectors

Table 2-8 presents the USB connectors.

Connector	Comment
ICEJ3	ICE USB connector on Nu-Link2-Me for power supply, debugging and programming from PC.
J2	USB FS connector on NuMaker-M032KI for power supply.

Table 2-8 USB Connectors

### 2.5.7 Power Switches

Table 2-9 presents the power switches.

Switch	Comment
ICEJPR1	Configures the target chip operating voltage at 1.8 V / 3.3 V / 5 V.
ICEJPR2	Configures the ICE chip operating voltage at 1.8 V / 3.3 V.
SW2	Configures the target chip operating voltage at 3.3 V / 5 V.

Table 2-9 Power Switches

### 2.5.8 Power Supply Models

#### 2.5.8.1 External Power Supply through Nu-Link2-Me to Target Chip

The external power supply source on Nu-Link2-Me is shown in Figure 2-5.

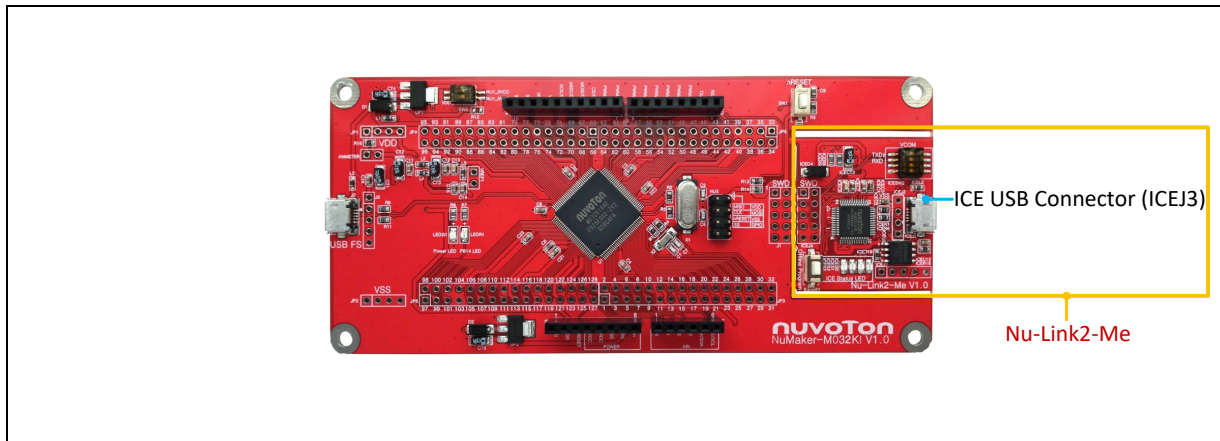

Figure 2-5 External Power Supply Sources on Nu-Link2-Me

To use ICEJ3 as external power supply source with Nu-Link2-Me, please follow the below steps:

1. Solder the resistor on ICEJPR1 (MCUVCC) depends on the target chip operating voltage.
2. Solder the resistor on ICEJPR2 (ICEVCC) depends on the ICE chip operating voltage.
3. Switch the SW2 to OFF.
4. Connect the external power supply to ICEJ3.

Table 2-10 presents all power models when supplies external power through Nu-Link2-Me. The Nu-Link2-Me external power sources are highlighted in yellow.

Model	Target Chip Voltage	ICEJ3	ICEJPR1 (MCUVCC) Selection <sup>[1]</sup>	ICEJPR2 (ICEVCC) Selection <sup>[2]</sup>	ICE Chip Voltage	SW2 Selection	J2	Vin	JP1
1	1.8 V	Connect to PC	1.8 V	1.8 V	1.8 V	Off	Ignore	Ignore	1.8 V output
2	3.3 V	Connect to PC	3.3 V (default)	3.3 V (default)	3.3 V	Off	Ignore	Ignore	3.3 V output
3	5 V	Connect to PC	5V	3.3 V (default)	3.3 V	Off	Ignore	Ignore	5 V output
X: Unused. <b>Note:</b> 1. 0 Ω should be soldered between ICEJPR1's MCVCC and 1.8 V / 3.3 V / 5 V. 2. 0 Ω should be soldered between ICEJPR2's ICEVCC and 1.8 V / 3.3 V.									

Table 2-10 Supply External Power through Nu-Link2-Me

2.5.8.2 External Power Supply through M032 platform to Target Chip

The external power supply sources on M032 platform are shown in Figure 2-6.

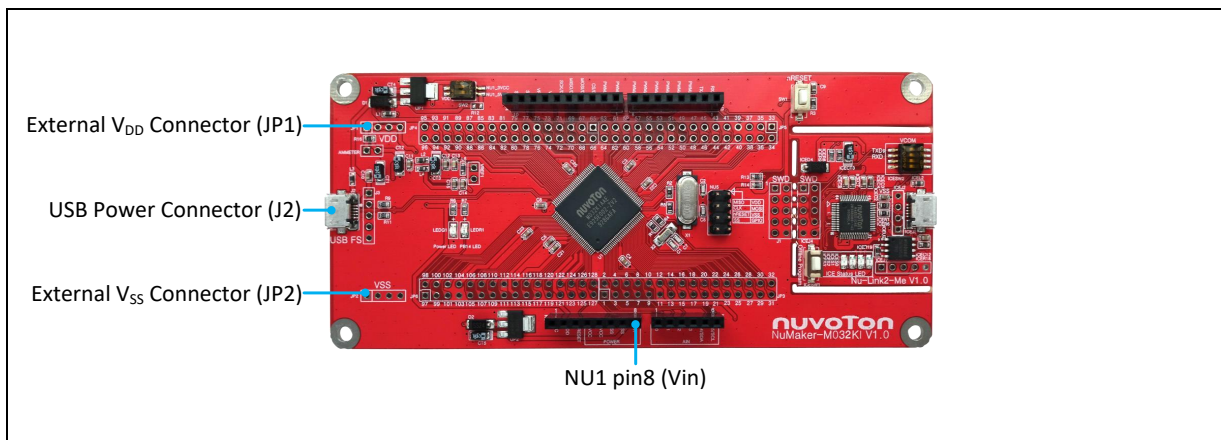

Figure 2-6 External Power Supply Sources on M032 platform

To use Vin or J2 as external power supply source, please follow the below steps:

1. Switch the SW2 depends on the target chip operating voltage.
2. Remove the resistor on ICEJPR1 (MCUVCC).
3. Solder the resistor on ICEJPR2 (ICEVCC) depends on the ICE chip operating voltage.
4. Connect the external power supply to Vin or J2.

To use JP1 as external power supply source, please follow the below steps:

1. Switch the SW2 to OFF.
2. Remove the resistor on ICEJPR1 (MCUVCC).
3. Solder the resistor on ICEJPR2 (ICEVCC) depends on the ICE chip operating voltage.
4. Connect ICEJ3 to PC.
5. Connect the external power supply to JP1.

To use Vin or J2 as external power supply source with Nu-Link2-Me separated from NuMaker-M032KI, please follow the below steps:

1. Switch the SW2 depends on the target chip operating voltage.
2. Separate the Nu-Link2-Me from NuMaker-M032KI.
3. Connect the external power supply to Vin or J2.

To use JP1 as external power supply source with Nu-Link2-Me separated from NuMaker-M032KI, please follow the below steps:

1. Switch the SW2 to OFF.
2. Separate the Nu-Link2-Me from NuMaker-M032KI.
3. Connect the external power supply to JP1.

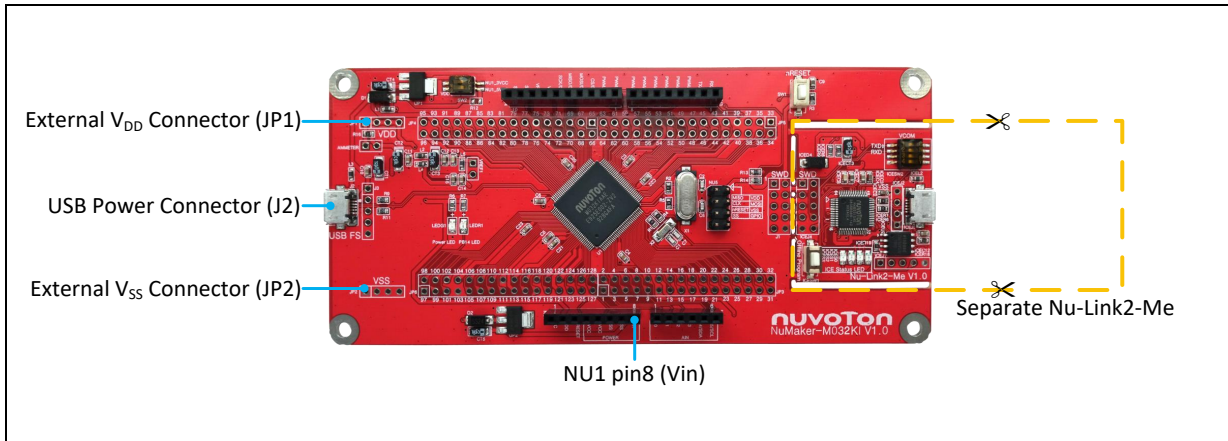

Figure 2-7 Separate the Nu-Link2-Me from NuMaker-M032KI

Table 2-11 presents all power models when supplies external power through M032 platform. The M032 platform external power sources are highlighted in yellow.

Model	Target Chip Voltage	Vin <sup>[1]</sup>	J2	ICEJ3	SW2 Selection	JP1	ICEJPR1 (MCUVCC) Selection <sup>[2]</sup>	ICEJPR2 (ICEVCC) Selection <sup>[3]</sup>	ICE Chip Voltage <sup>[4]</sup>
4	3.3 V	7 V ~ 12 V Input	X	Ignore	NU1 3VCC	3.3 V output	Remove resistor	3.3 V	3.3 V
5	3.3 V	X	Connect to PC	Ignore	NU1 3VCC	3.3 V output	Remove resistor	3.3 V	3.3 V
6	5 V	7 V ~ 12 V Input	X	Ignore	NU1 5VCC	5 V output	Remove resistor	3.3 V	3.3 V
7	5 V	X	Connect to PC	Ignore	NU1 5VCC	5 V output	Remove resistor	3.3 V	3.3 V
8	1.8 V ~ 3.6 V	Ignore <sup>[5]</sup>	Ignore <sup>[5]</sup>	Connect to PC	OFF	DC Input 1.8 V ~ 3.6 V	Remove resistor	1.8 V / 3.3 V	1.8 V / 3.3 V
9	1.8 V ~ 3.6 V	Ignore <sup>[5]</sup>	Ignore <sup>[5]</sup>	Nu-Link2-Me removed	OFF	DC Input 1.8 V ~ 3.6 V	X	X	X

X: Unused.

**Note:**

1. The Vin input voltage will be converted by voltage regulator UP2 to 5 V.
2. 0Ω should be removed from ICEJPR1's MCVCC and 1.8 V / 3.3 V / 5 V.
3. 0Ω should be soldered between ICEJPR2's ICEVCC and 1.8 V / 3.3 V.
4. The ICE chip voltage should be close to the target chip voltage.
5. JP1 external power input only provides voltage to target chip. Supply external power to Vin or J2 can provide 5V to NU1 pin5 (5V) and 3.3V to NU1 pin4 (3VCC).

Table 2-11 Supply External Power for M032 platform



### 2.5.9 External Reference Voltage Connector

Table 2-13 presents the external reference voltage connector.

Connector	Comment
VREF1	Connector for user to easily connect to the external reference voltage pin of the target chip. User needs to remove the L5 ferrite bead.

Table 2-12 External Reference Voltage Connector

### 2.5.10 Ammeter Connector

Table 2-13 presents the ammeter connector.

Connector	Comment
AMMETER	Connector for user to easily measure the target chip power consumption. User needs to remove the R16 resistor.

Table 2-13 Ammeter Connector

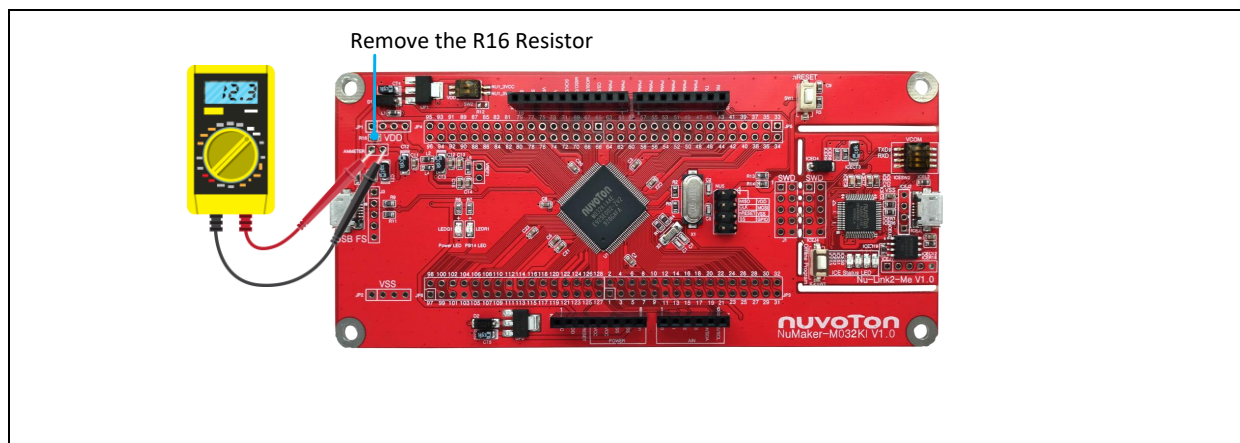

Figure 2-8 Wiring between Ammeter Connector and Ammeter

### 2.5.11 Extension Connectors

Table 2-14 presents the extension connectors.

Connector	Comment
JP3, JP4, JP5 and JP6	Full pins extension connectors on the NuMaker-M032KI.
NU1, NU2, NU3 and NU4	Arduino UNO compatible pins on the NuMaker-M032KI.

Table 2-14 Extension Connectors

### 2.5.12 Push-Buttons

Table 2-15 presents the push-buttons.

Component	Comment
ICESW1	Off-line program button to start off-line programming the target chip.
SW1	Reset button to reset the target chip.

Table 2-15 Push-Buttons

### 2.5.13 LEDs

Table 2-16 presents the LEDs.

Component	Comment
Power LED	The power LED indicates that the NuMaker-M032KI is powered.
PB14 LED	The LED is connected to the target chip PB.14.
ICES0, ICES1, ICES2 and ICES3	Nu-Link2-Me status LED.

Table 2-16 LEDs

## 2.6 Nu-Link2-Me

The Nu-Link2-Me is a debugger and programmer that supports on-line programming and debugging through SWD interface. The on-board 16 Mbit SPI Flash allows it to off-line program the target microcontroller. Additionally, the Nu-Link2-Me provides virtual COM port (VCOM) function to print out messages on PC. Table 2-17 presents how to set the VCOM function by ICESW2.

ICESW2		
Pin	Function	Comment
1	TXD	<b>On:</b> Connect target chip PB.13 (UART0_TXD) to Nu-Link2-Me. <b>Off:</b> Disconnect target chip PB.13 (UART0_TXD) to Nu-Link2-Me.
2	RXD	<b>On:</b> Connect target chip PB.12 (UART0_RXD) to Nu-Link2-Me. <b>Off:</b> Disconnect target chip PB.12 (UART0_RXD) to Nu-Link2-Me.
<b>Note:</b> Pin 3 and 4 is unused.		

Table 2-17 VCOM Function of Nu-Link2-Me



### 2.7 PCB Placement

Figure 2-9 and Figure 2-10 show the front and rear placement of NuMaker-M032KI.

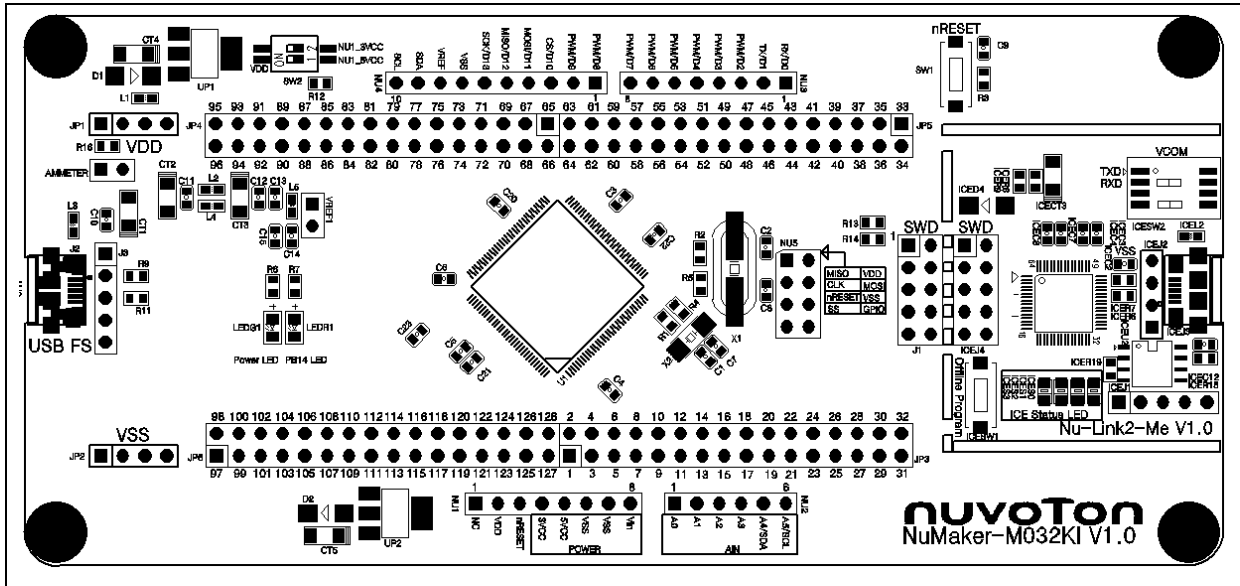

Figure 2-9 Front Placement

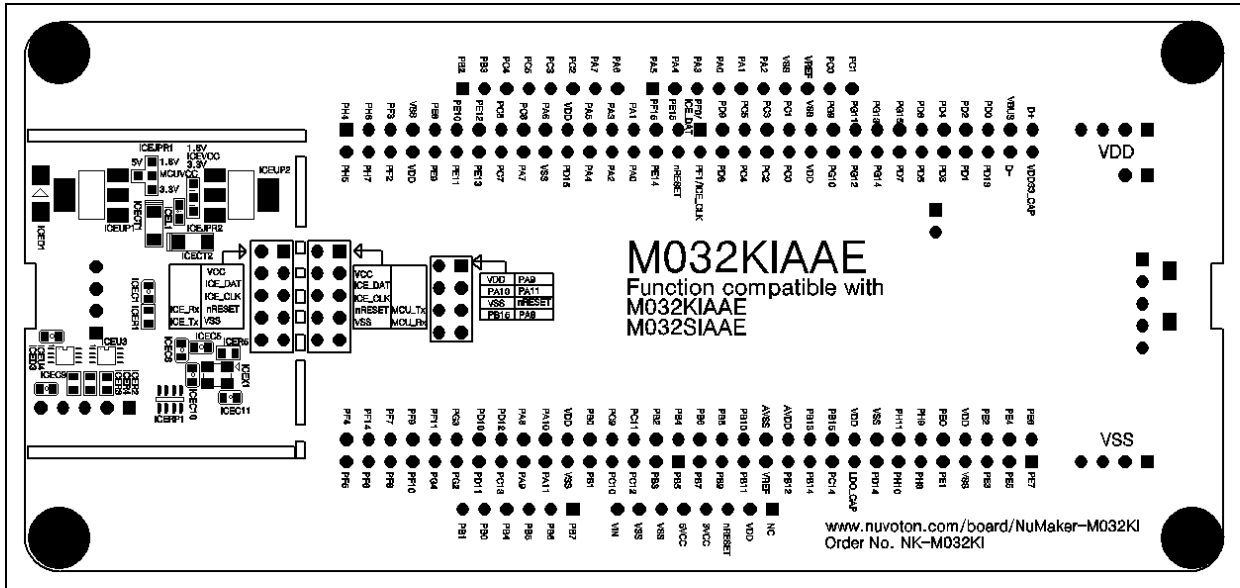

Figure 2-10 Rear Placement

### 3 QUICK START

#### 3.1 Toolchains Supporting

Install the preferred toolchain. Please make sure at least one of the toolchains has been installed.

- [KEIL MDK Nuvoton edition M0/M23](#)
- [IAR EWARM](#)
- [NuEclipse \(GCC\)\(Windows\)](#)
- [NuEclipse \(GCC\)\(Linux\)](#)

#### 3.2 Nuvoton Nu-Link Driver Installation

Download and install the latest Nuvoton Nu-Link Driver.

- Download and install [Nu-Link\\_Keil\\_Driver](#) when using Keil MDK.
- Download and install [Nu-Link\\_IAR\\_Driver](#) when using IAR EWARM.
- Skip this step when using NuEclipse.

Please install the Nu-Link USB Driver as well at the end of the installation. The installation is presented in Figure 3-1 and Figure 3-2.

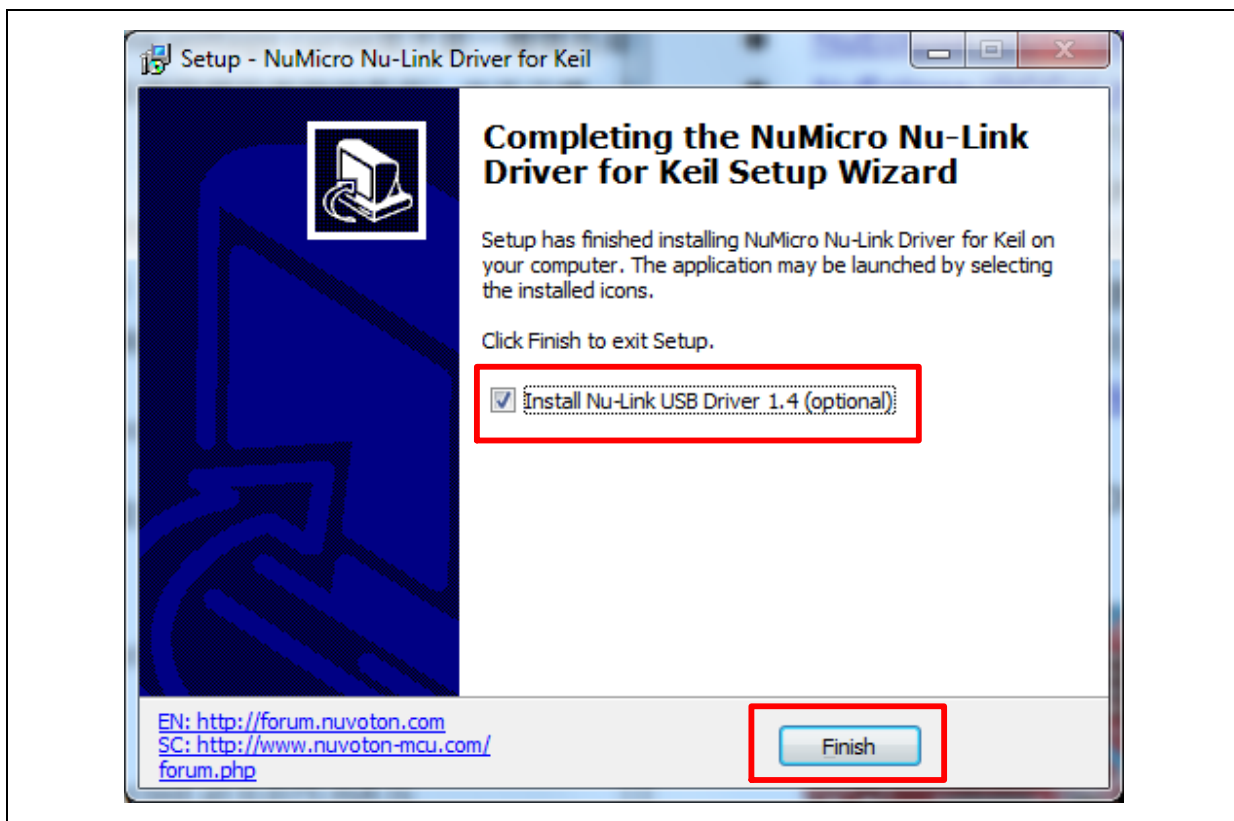

Figure 3-1 Nu-Link USB Driver Installation Setup



Figure 3-2 Nu-Link USB Driver Installation

### 3.3 BSP Firmware Download

Download and unzip the [Board Support Package \(BSP\)](#).

### 3.4 Hardware Setup

1. Open the virtual COM (VCOM) function by changing Nu-Link2-Me VCOM Switch No. 1 and 2 to ON.

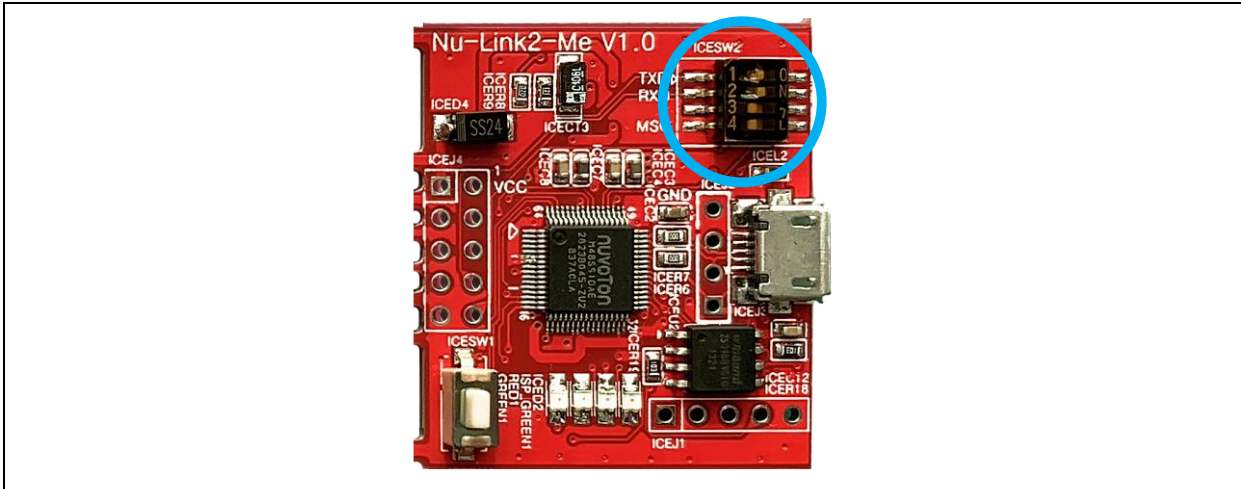

Figure 3-3 Open VCOM Function

2. Connect the ICE USB connector shown in Figure 3-4 to the PC USB port through USB cable.

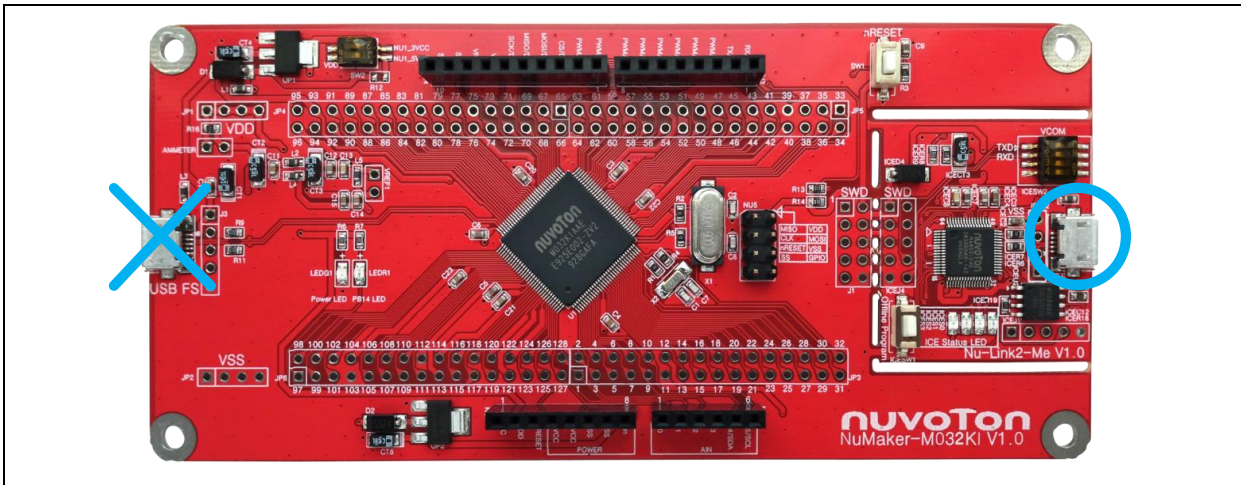

Figure 3-4 ICE USB Connector

3. Find the “Nuvoton Virtual COM Port” on the Device Manger as Figure 3-5.

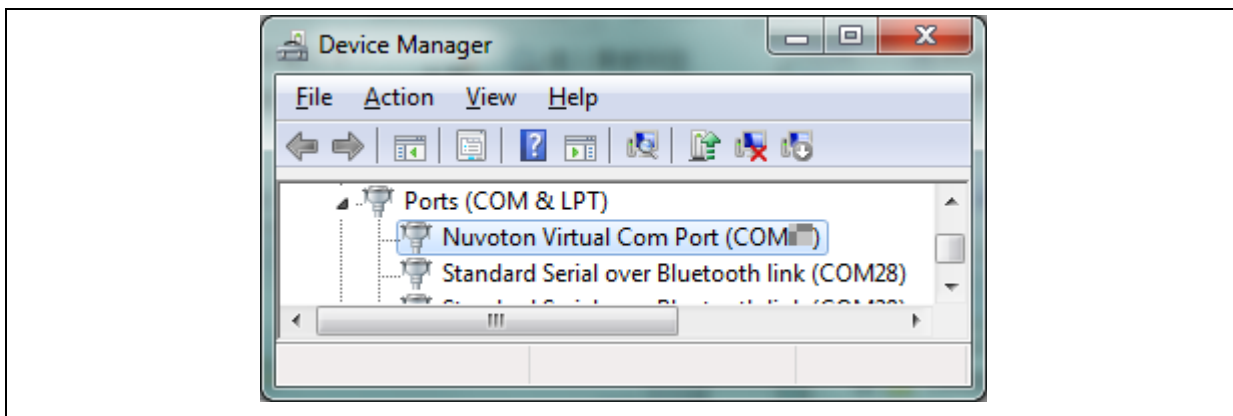

Figure 3-5 Device Manger

4. Open a serial port terminal, PuTTY for example, to print out debug message. Set the speed to 115200. Figure 3-6 presents the PuTTY session setting.

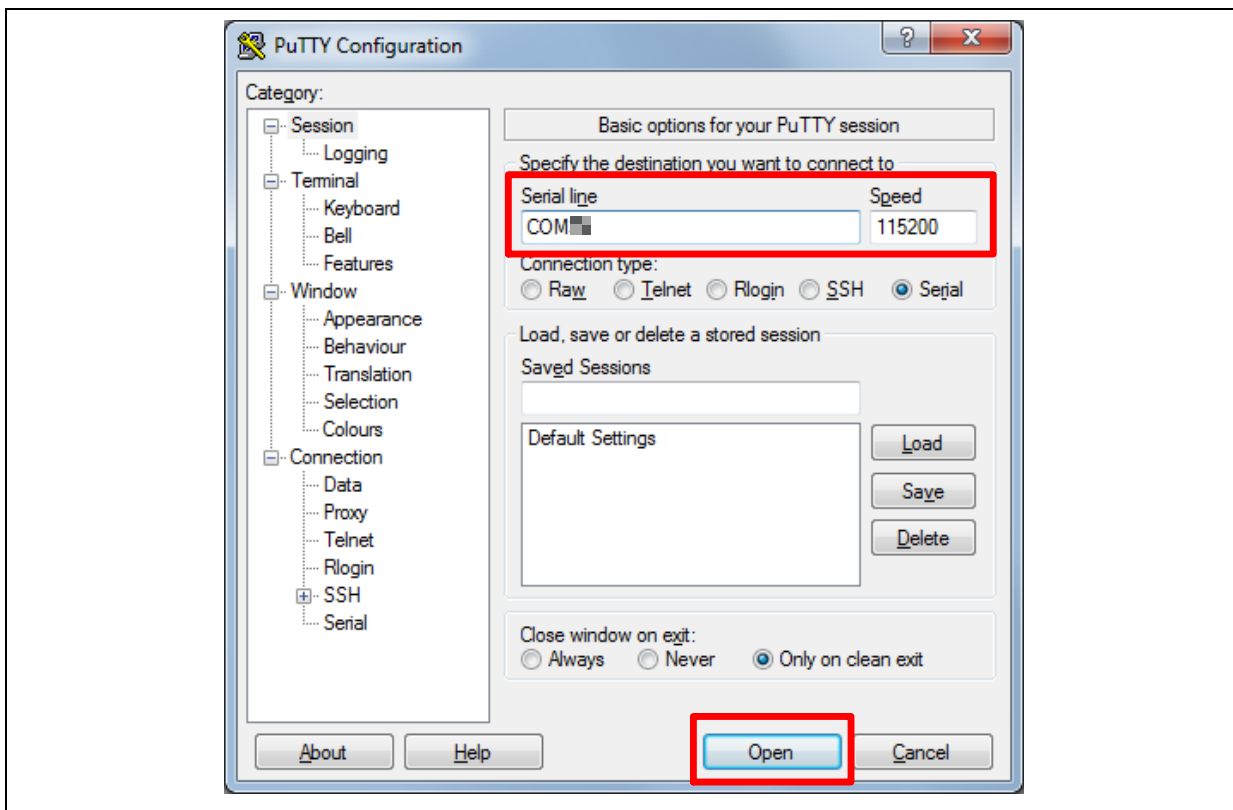

Figure 3-6 PuTTY Session Setting



### 3.5 Find the Example Project

Use the “Template” project as an example. The project can be found under the BSP folder as shown in Figure 3-7.

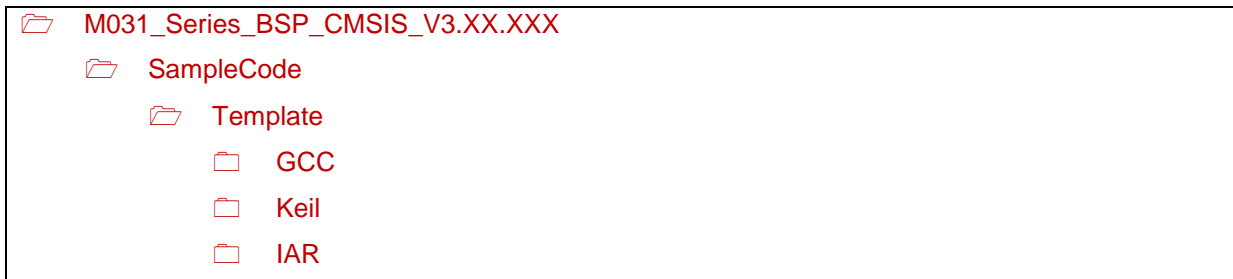

Figure 3-7 Template Project Folder Path

### 3.6 Execute the Project under Toolchains

Open and execute the project under the toolchain. The section 3.6.1, 0, and 3.6.3 describe the steps of executing project in Keil MDK, IAR EWARM and NuEclipse, respectively.

#### 3.6.1 Keil MDK

This section provides steps to beginners on how to run a project by using Keil MDK.

1. Double click the “Template.uvproj” to open the project.

**Note:** If Figure 3-8 warning message jumps out, please migrate to version 5 formats as shown in Figure 3-9. The “.uvproj” filename extension will change to “.uvprojx”.

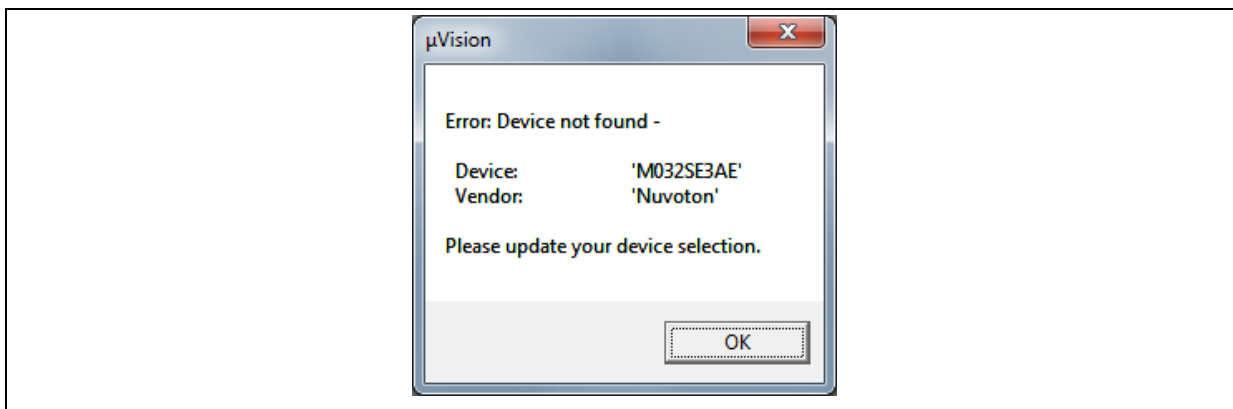

Figure 3-8 Warning Message of “Device not found”

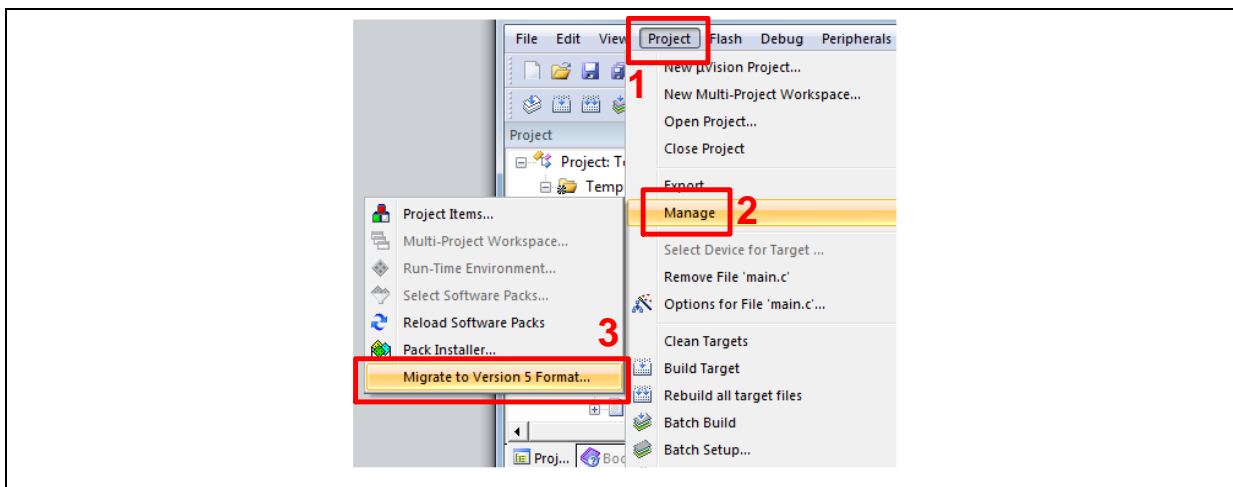

Figure 3-9 Project File Migrate to Version 5 Format

2. Make sure the debugger is “Nuvoton Nu-Link Debugger” as shown in Figure 3-10 and Figure 3-11.

**Note:** If the dropdown menu in Figure 3-10 does not contain “Nuvoton Nu-Link Debugger” item, please rework section 3.2.

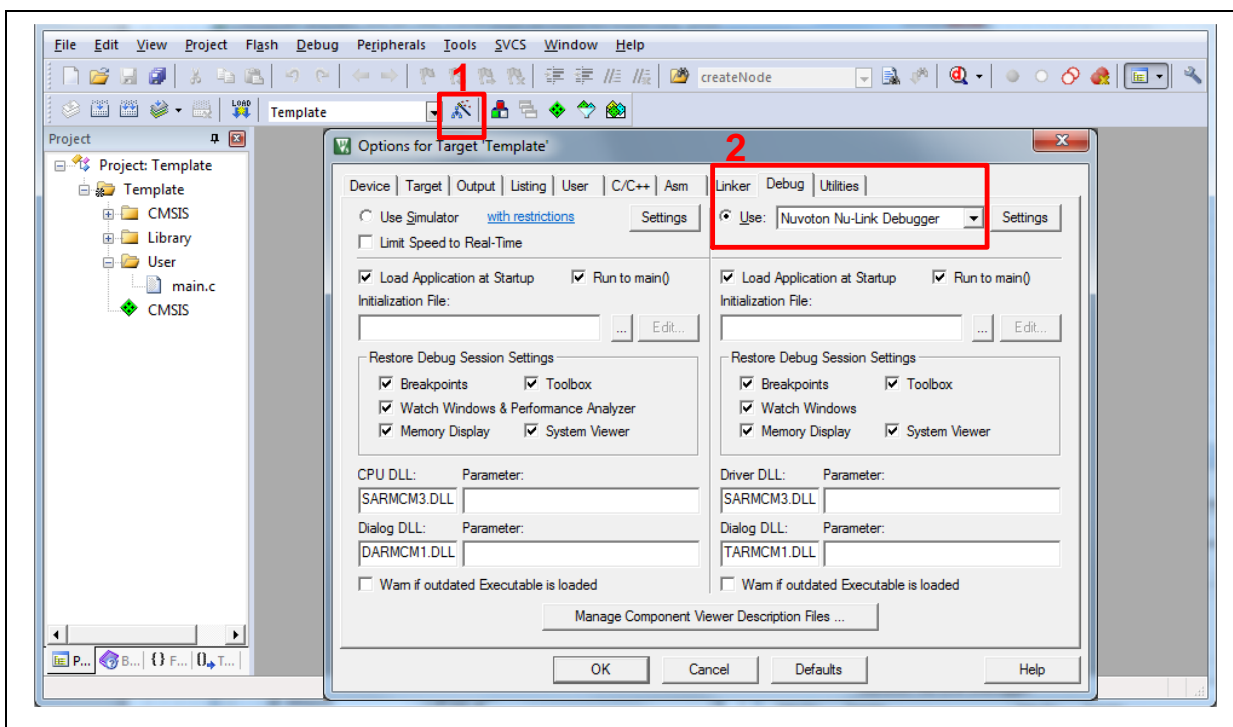

Figure 3-10 Debugger Setting in Options Window

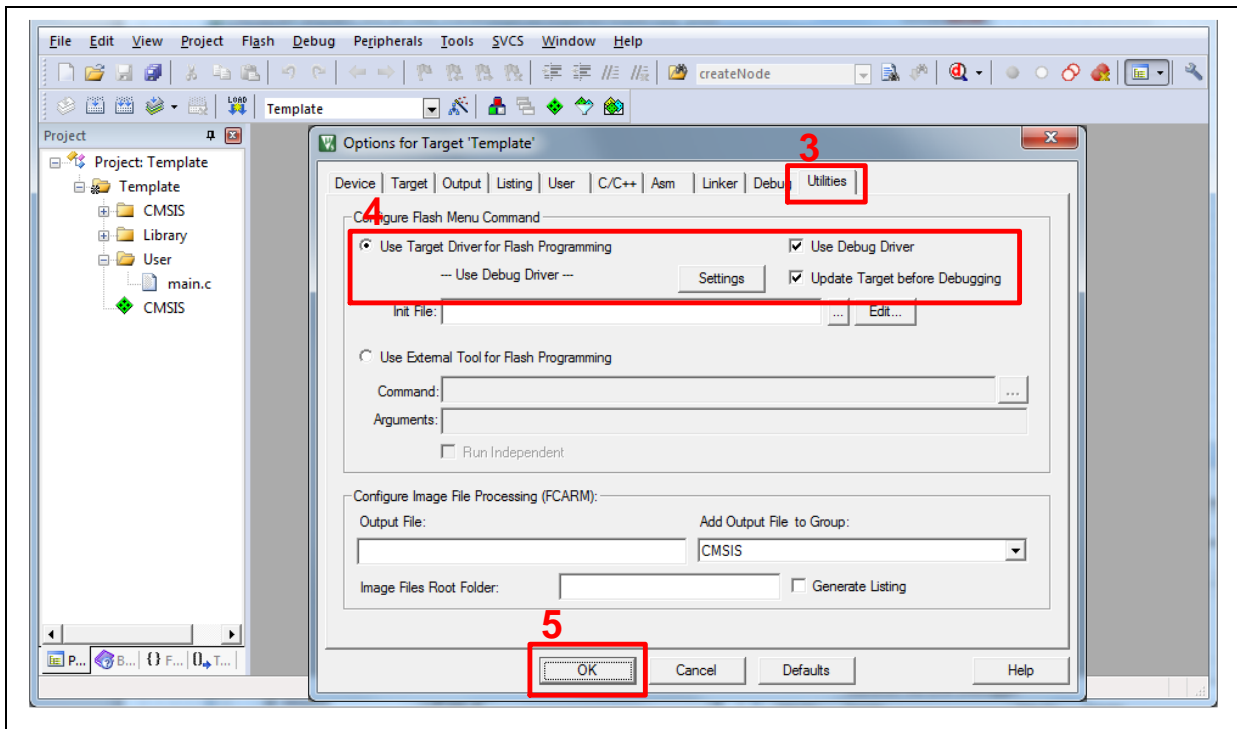

Figure 3-11 Programming Setting in Options Window

3. Rebuild all target files. After successfully compile the project, download code to the flash memory. Click “Start/Stop Debug Section” button can enter debug mode.

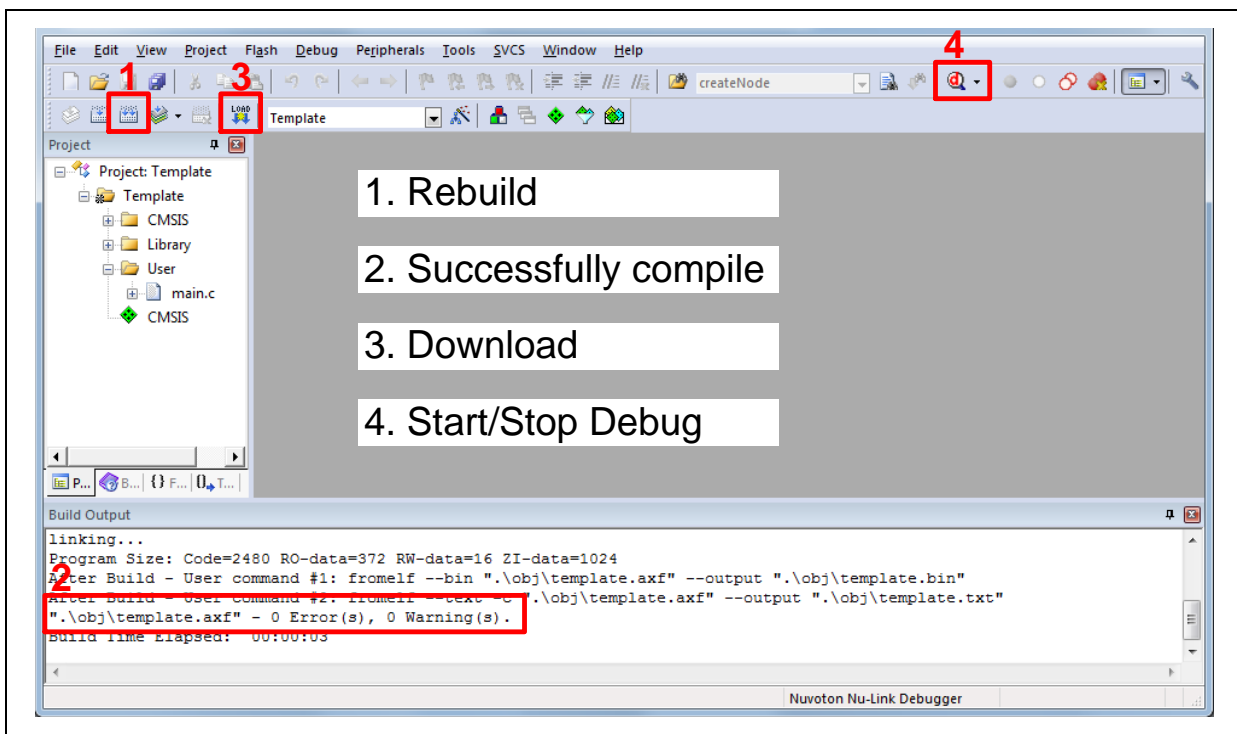

Figure 3-12 Compile and Download the Project

4. Figure 3-13 shows the debug mode under Keil MDK. Click “Run” and the debug message will be printed out as shown in Figure 3-14. User can debug the project under debug mode by checking



source code, assembly language, peripherals' registers, and setting breakpoint, step run, value monitor, etc.

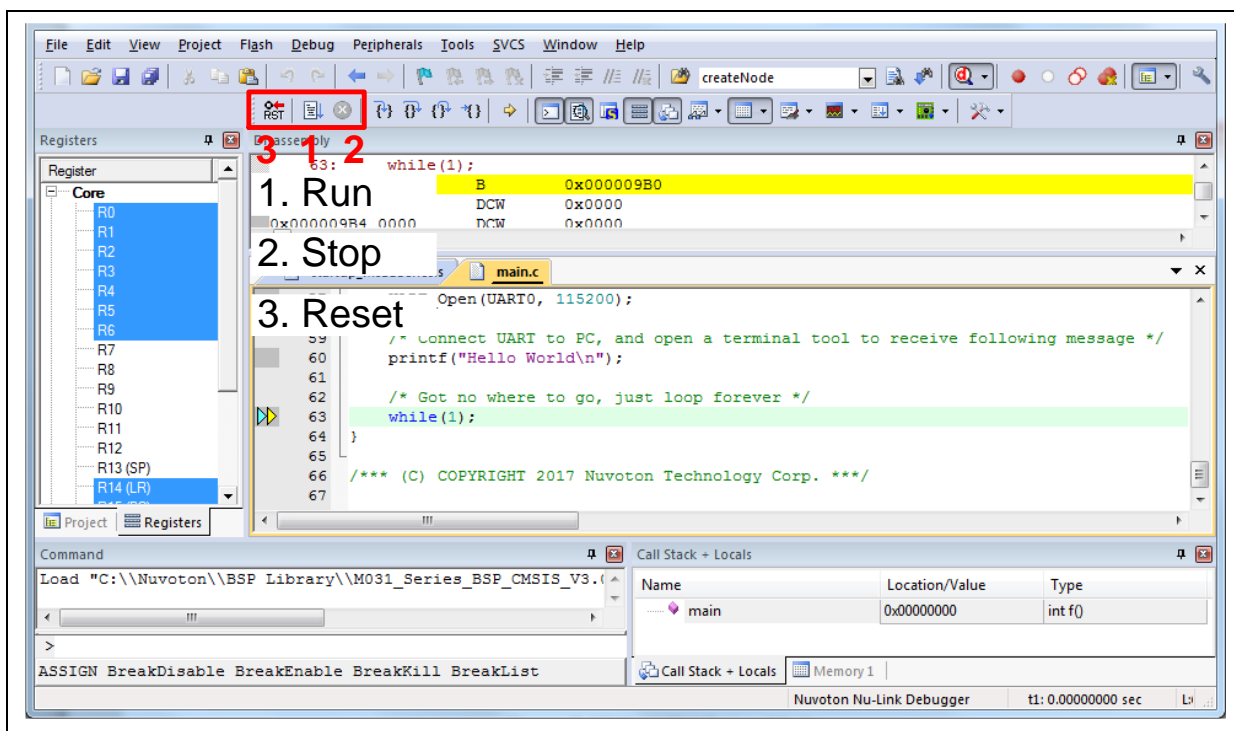

Figure 3-13 Keil MDK Debug Mode



Figure 3-14 Debug Message on Serial Port Terminal Windows

### 3.6.2 IAR EWARM

This section provides steps to beginners on how to run a project by using IAR EWARM.

1. Double click the “Template.eww” to open the project.
2. Make sure the toolbar contain “Nu-Link” item as shown in Figure 3-15.

**Note:** If the toolbar does not contain “Nu-Link” item, please rework section 3.2.

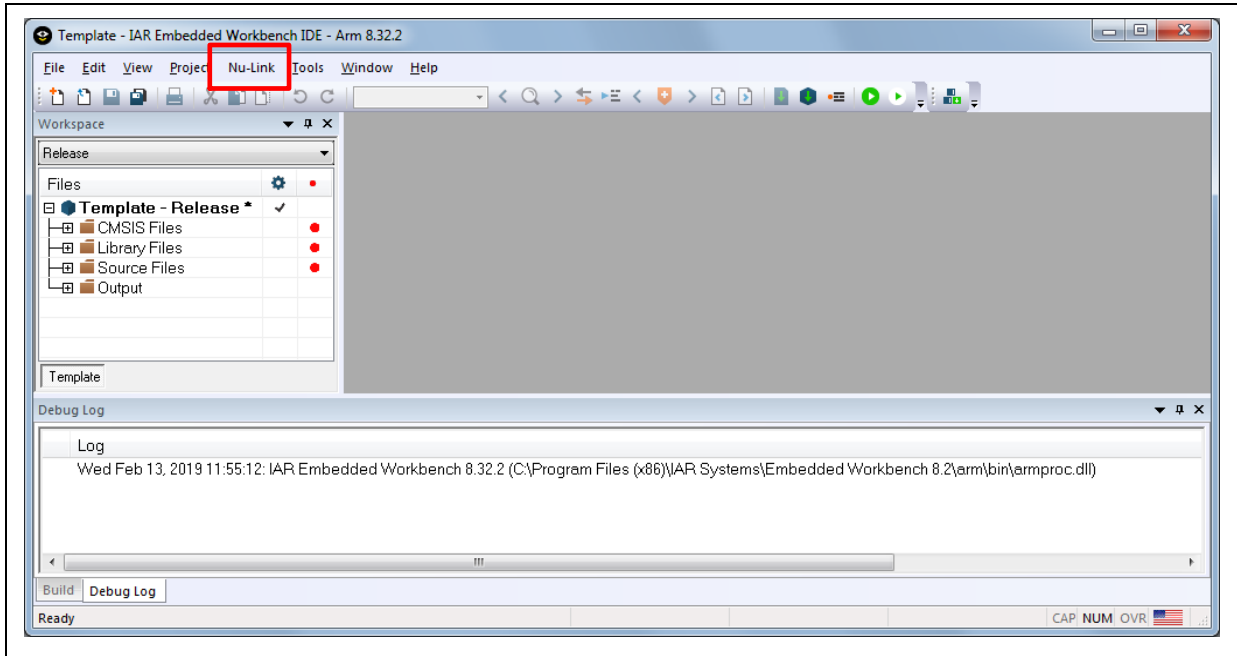

Figure 3-15 IAR EWARM Window

3. Make target file as presented in Figure 3-16. After successfully compile the project, download code to the flash memory and enter debug mode.

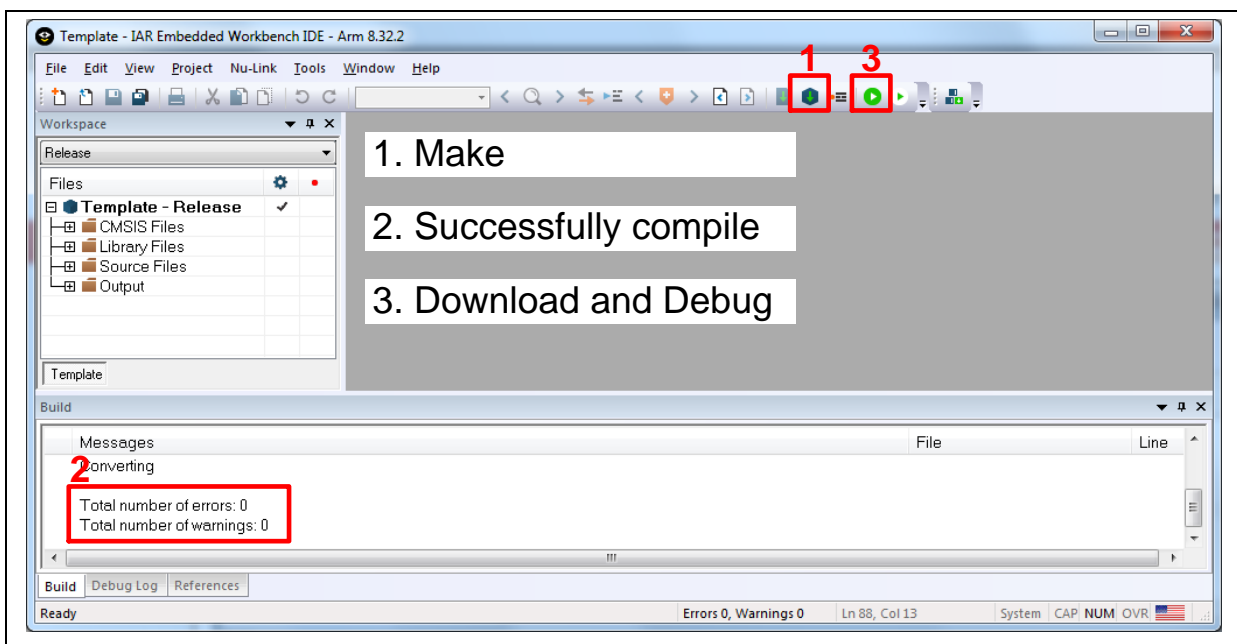

Figure 3-16 Compile and Download the Project

- Figure 3-17 shows the debug mode under IAR EWARN. Click “Go” and the debug message will be printed out as shown in Figure 3-18. User can debug the project under debug mode by checking source code, assembly language, peripherals’ registers, and setting breakpoint, step run, value monitor, etc.

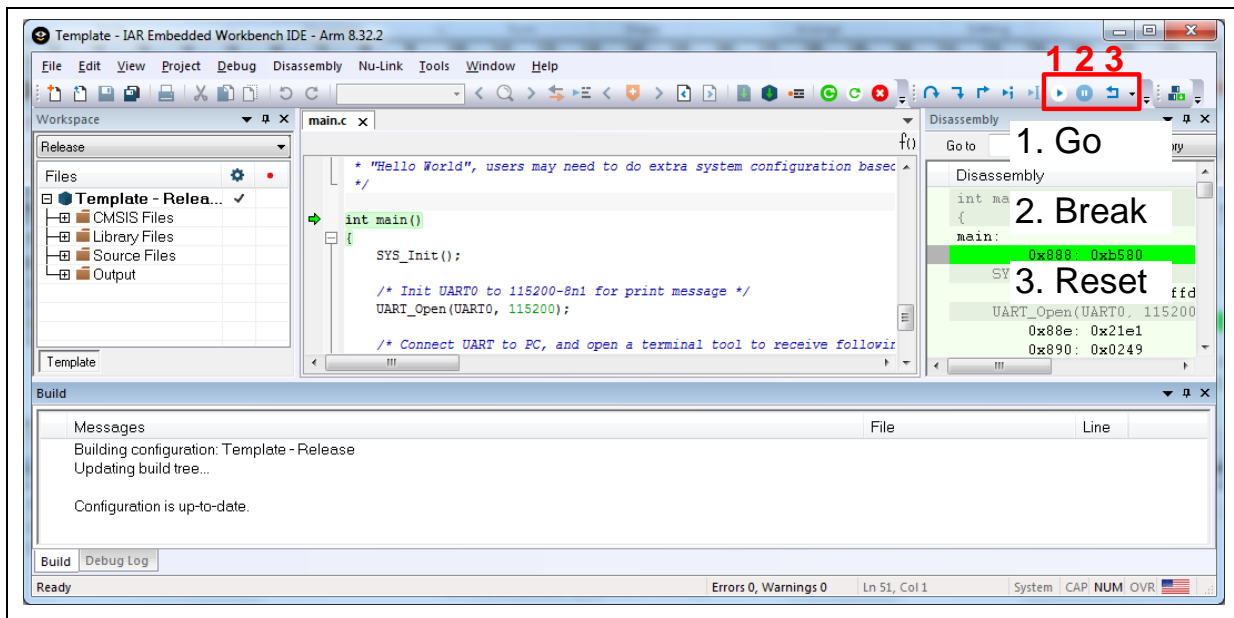

Figure 3-17 IAR EWARM Debug Mode

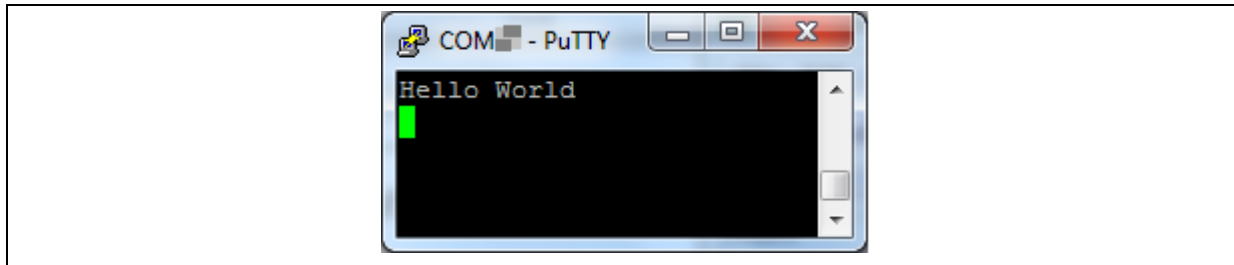

Figure 3-18 Debug Message on Serial Port Terminal Windows

### 3.6.3 NuEclipse

This section provides steps to beginners on how to run a project by using NuEclipse. Please make sure the filenames and project folder path contain neither invalid character nor space.

1. Double-click NuEclipse.exe to open the toolchain.
2. Import the “Template” project by following the steps presented in Figure 3-19 and Figure 3-20.

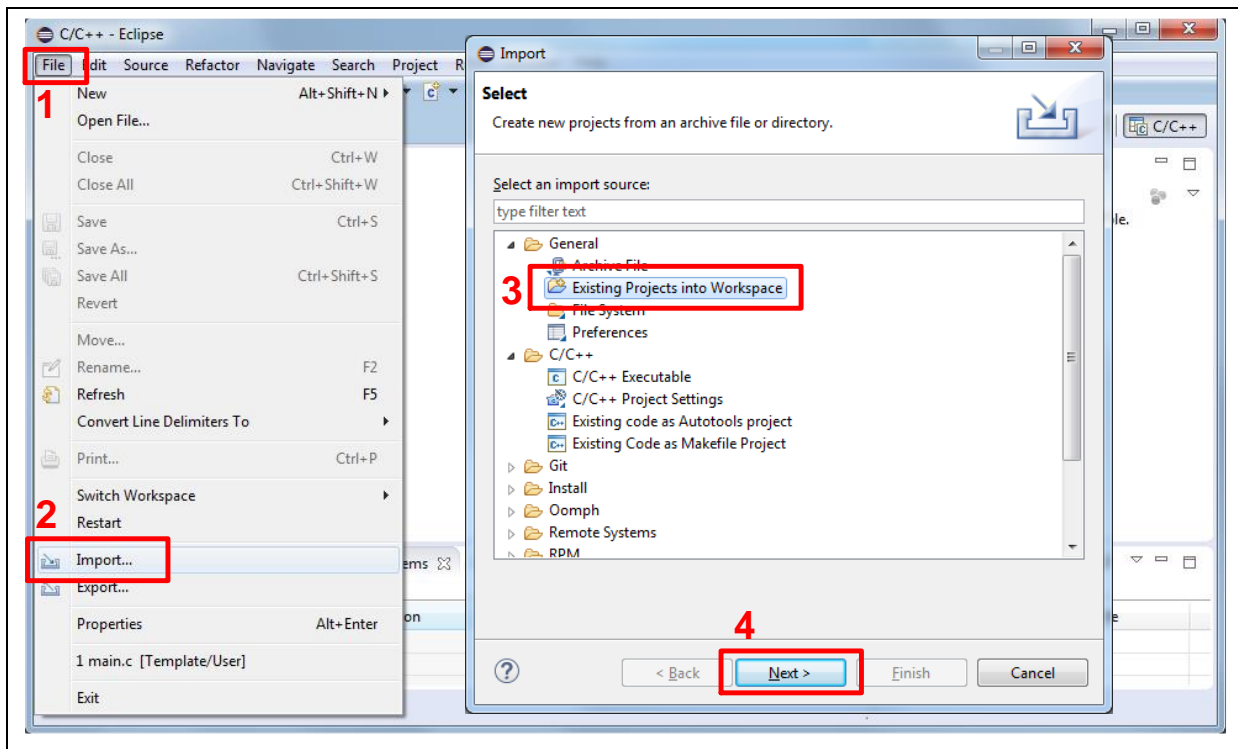

Figure 3-19 Import the Project in NuEclipse

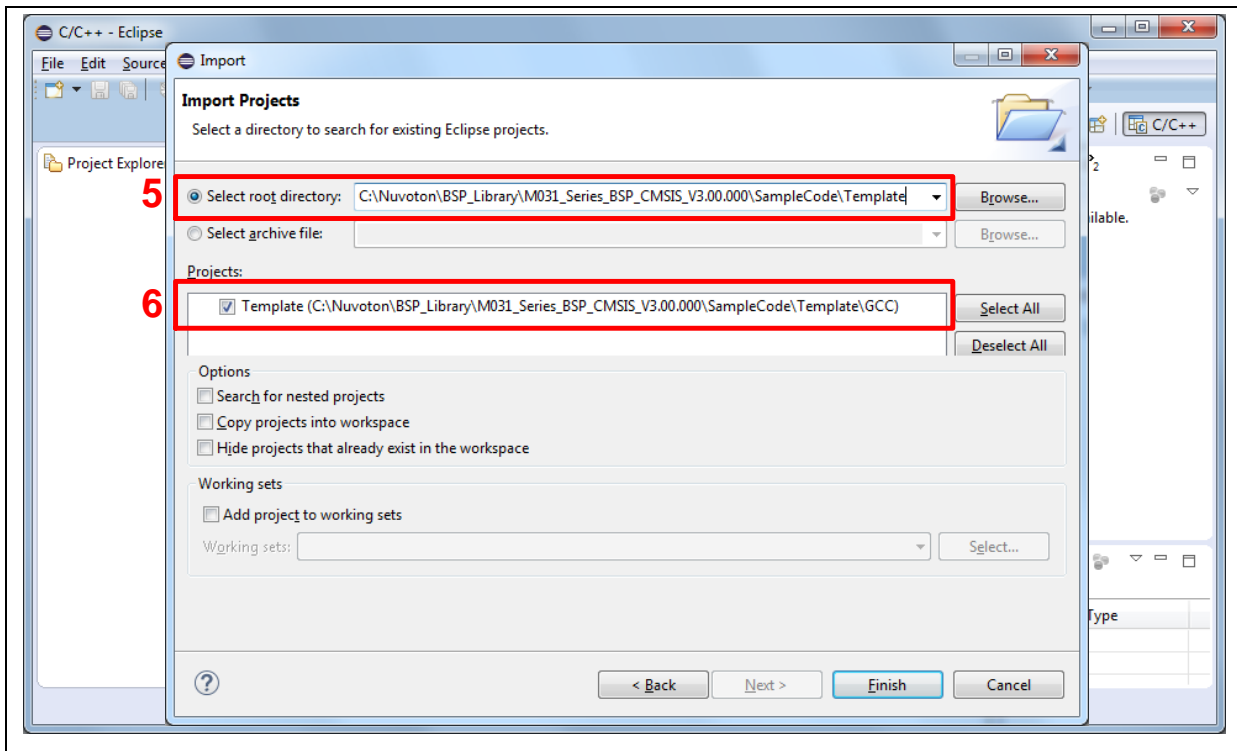

Figure 3-20 Import Projects Windows

3. Click the “Template” project and find the project properties as shown in Figure 3-21. Make sure the settings are the same as settings in Figure 3-22.

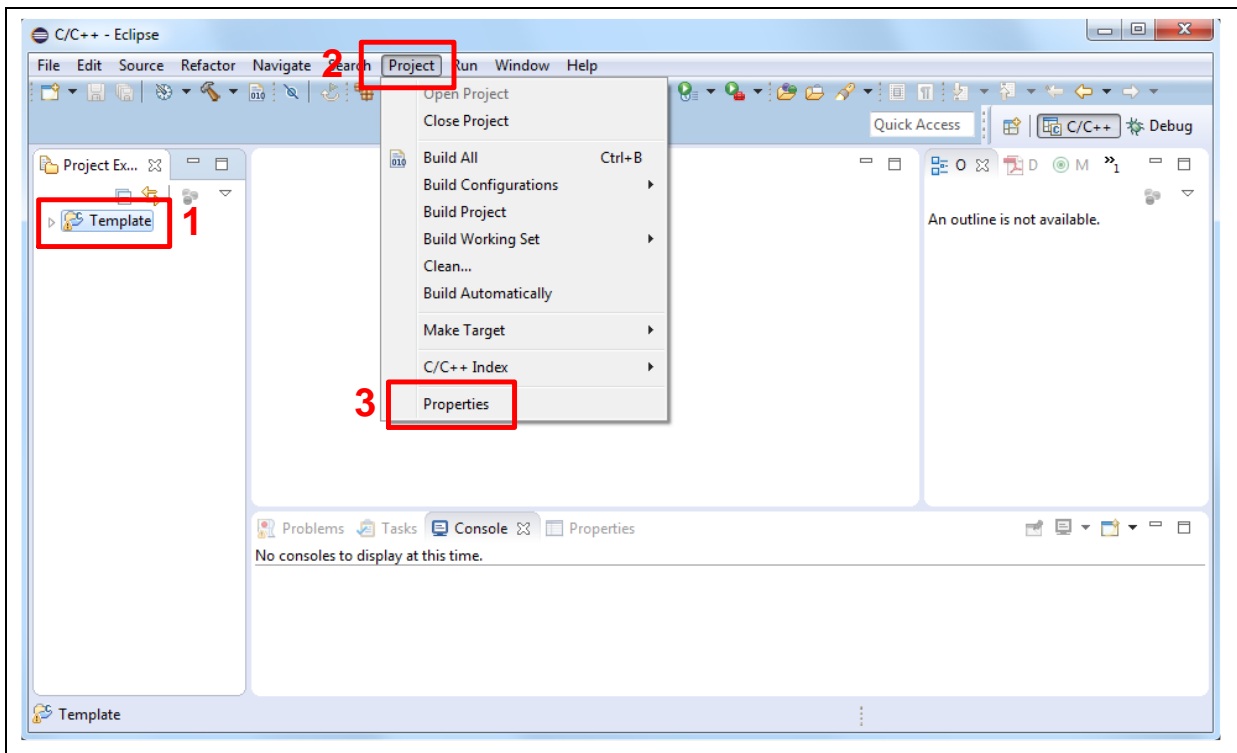

Figure 3-21 Open Project Properties Window

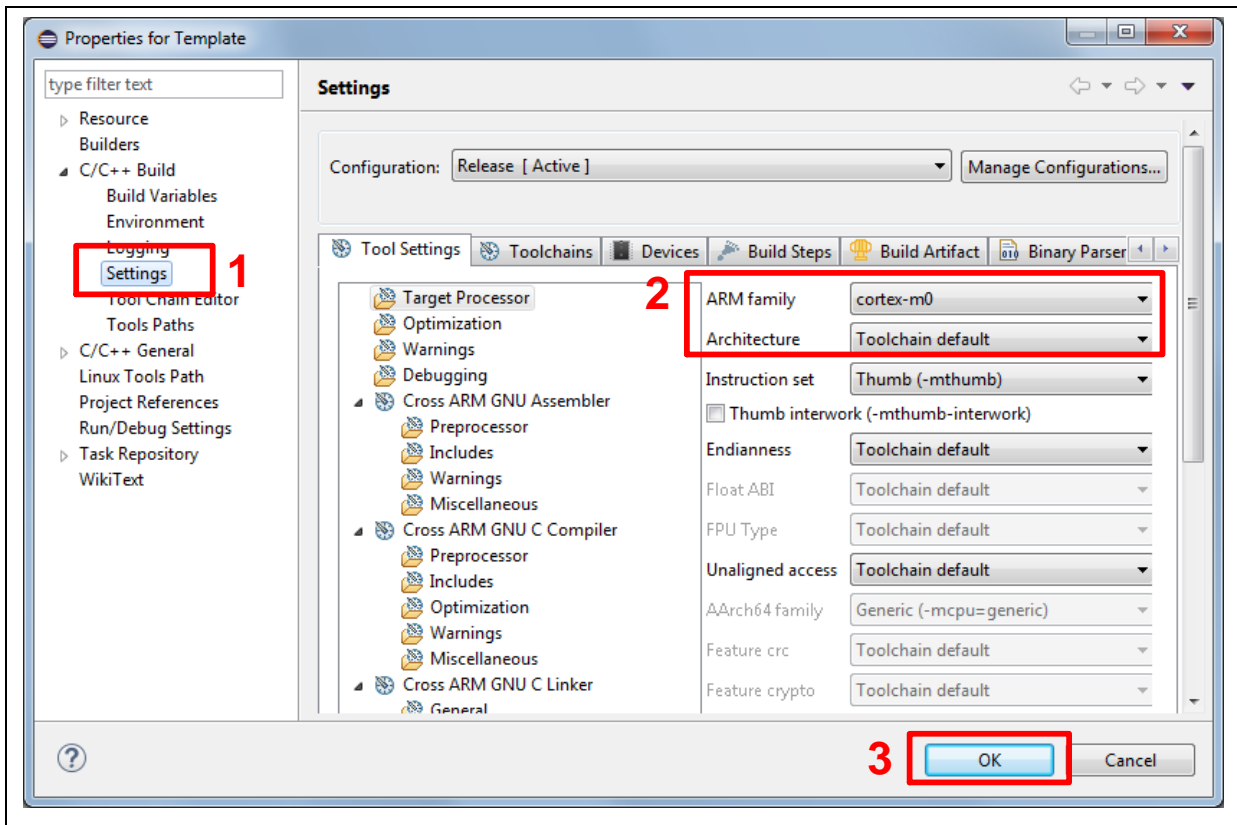

Figure 3-22 Project Properties Settings

4. Click the “Template” project and build the project.

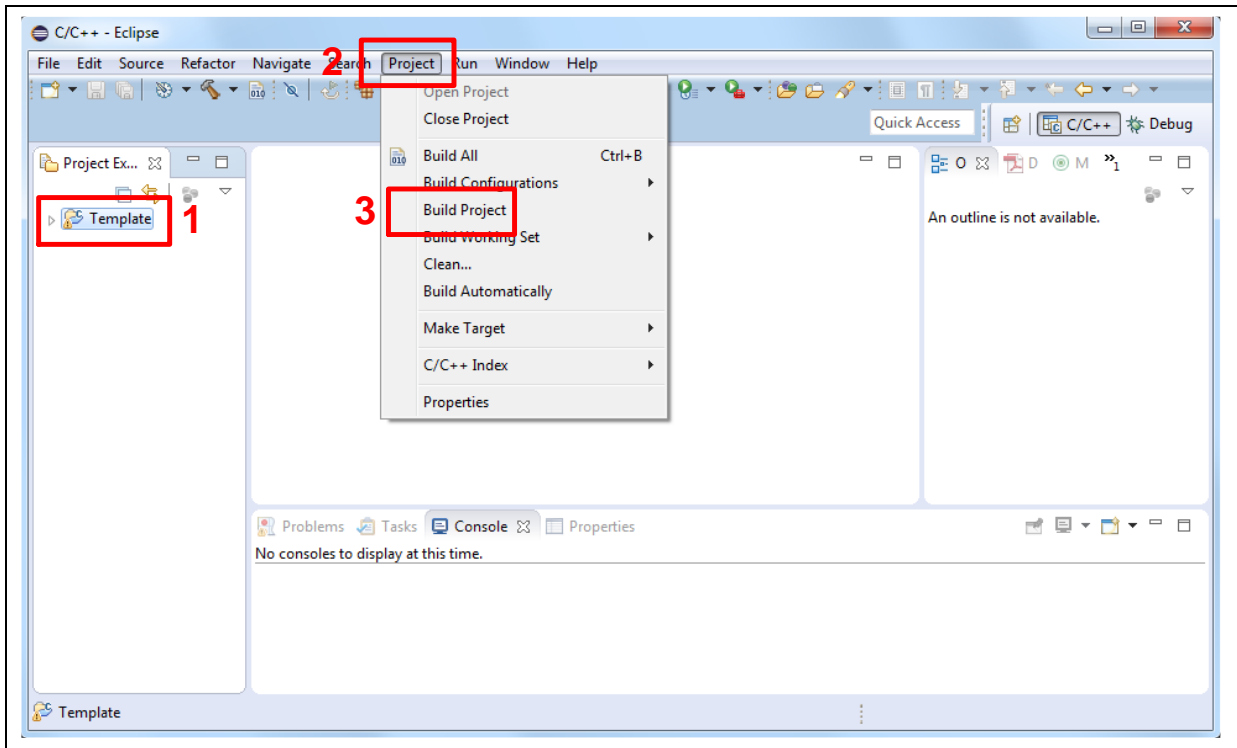

Figure 3-23 Build Project

- After the project is built, click the “Template” project and set the “Debug Configuration” as shown in Figure 3-24. Follow the settings presented in Figure 3-25, Figure 3-26 and Figure 3-27 to enter debug mode.

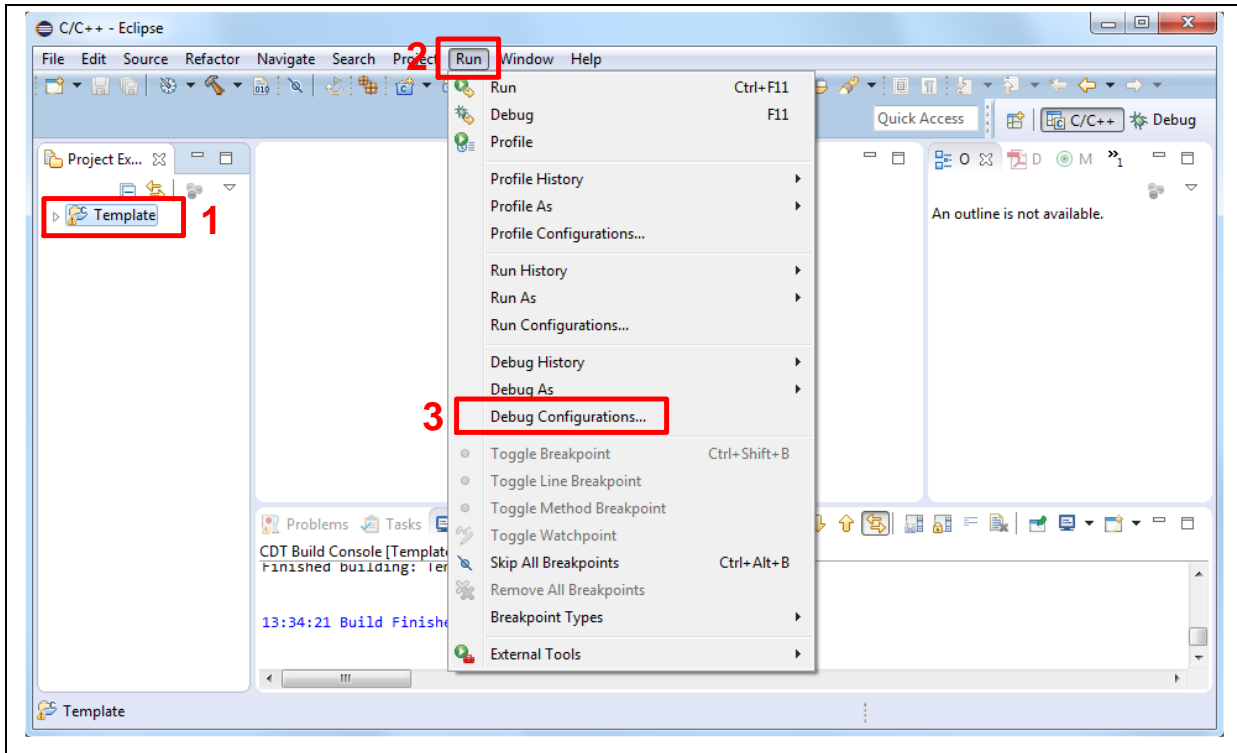
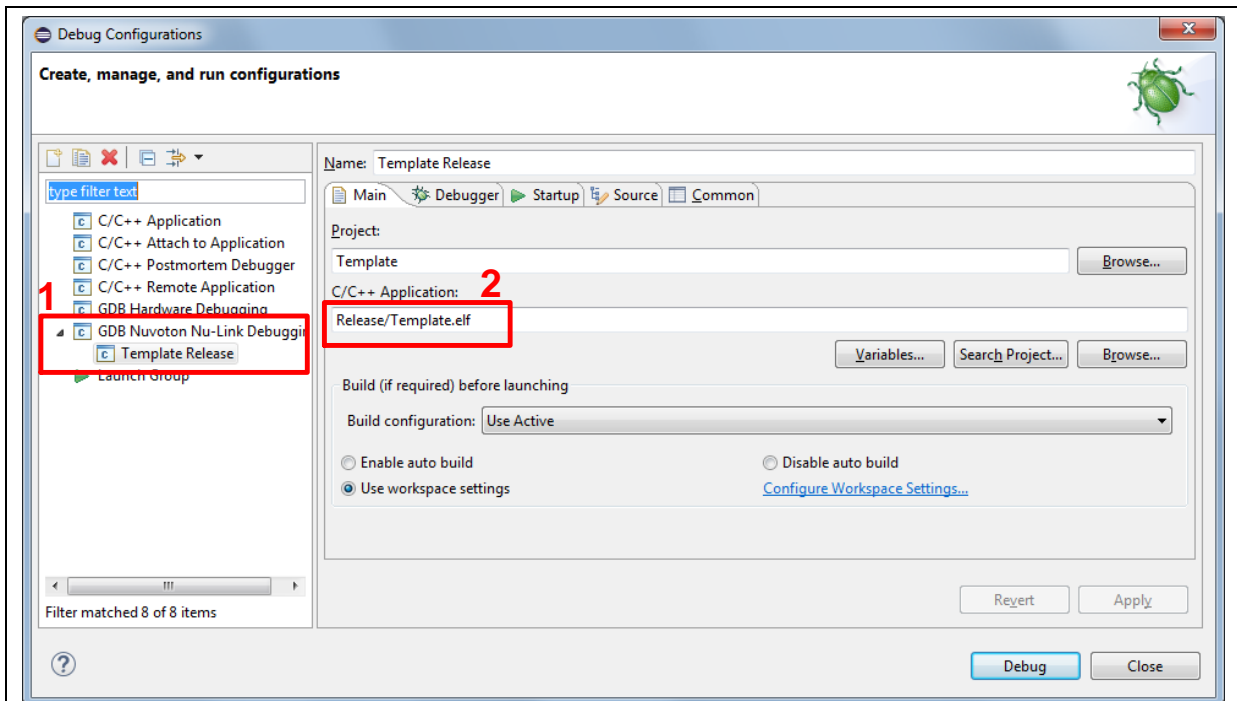

Figure 3-24 Open Debug Configuration



**Note 1:** Double click the “GDB Nuvoton Nu-Link Debugging” to create the subitem.

**Note 2:** After the project is built, the “\*.elf” file will be shown in “C/C++ Application” frame.

Figure 3-25 Main Tab Configuration

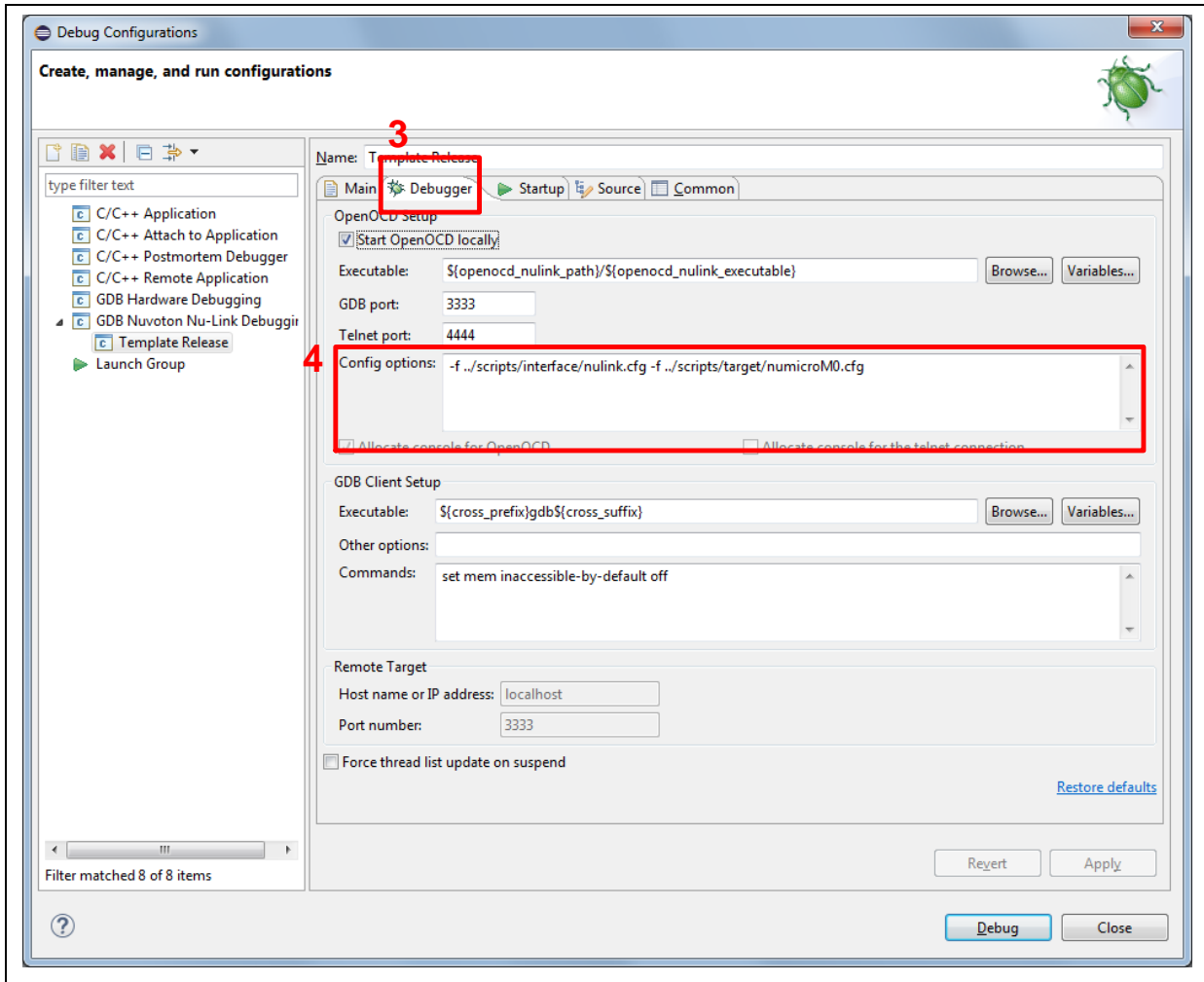
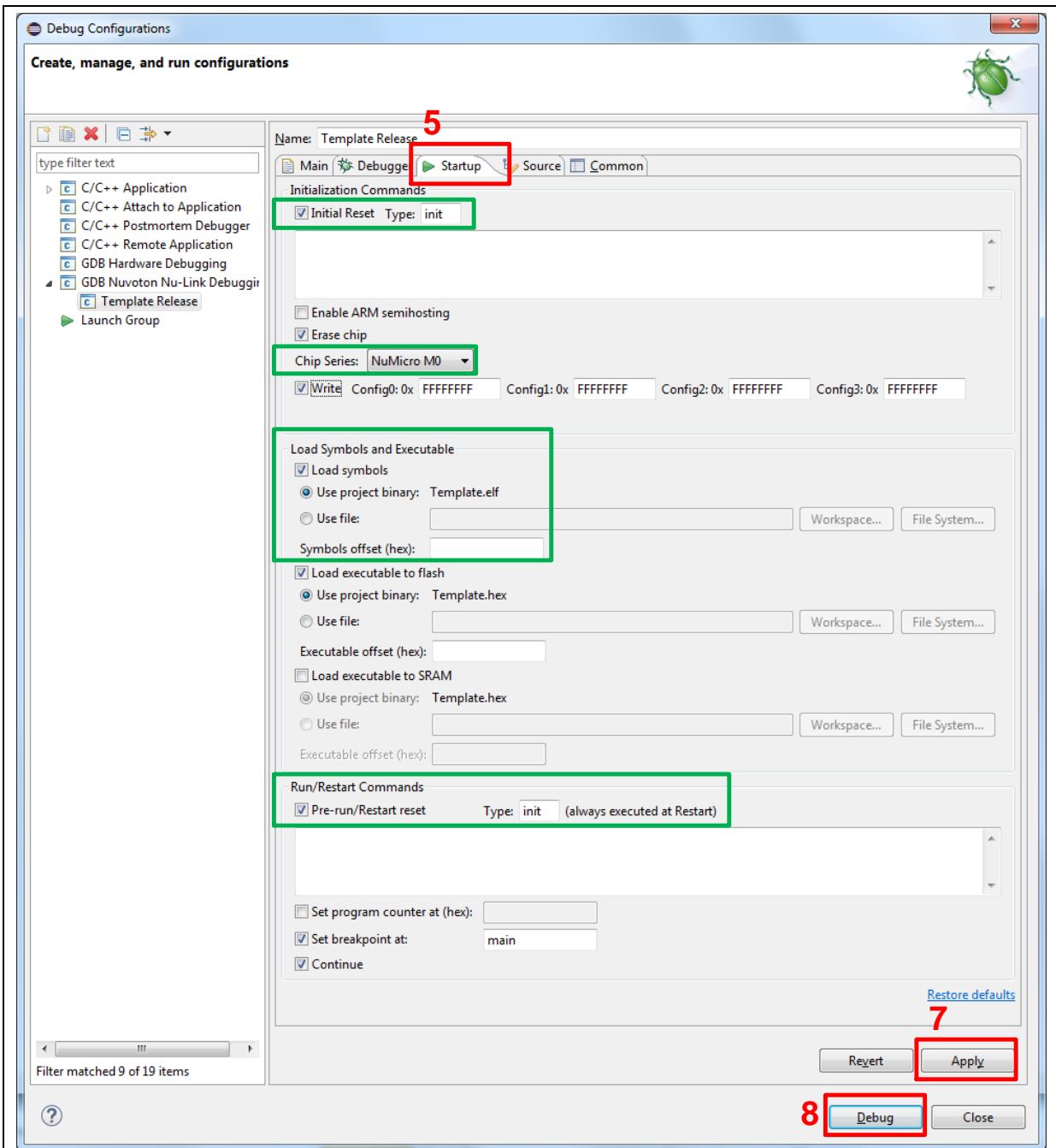

Figure 3-26 Debugger Tab Configuration





**Note 1:** Users must follow those settings highlighted in green.

**Note 2:** Users can configure other settings depend on the needs.

Figure 3-27 Startup Tab Configuration

- Figure 3-28 shows the debug mode under NuEclipse. Click “Resume” and the debug message will be printed out as shown in Figure 3-29. User can debug the project under debug mode by checking source code, assembly language, peripherals’ registers, and setting breakpoint, step run, value monitor, etc. For more information about how to use NuEclipse, please refer to the NuEclipse User Manual.

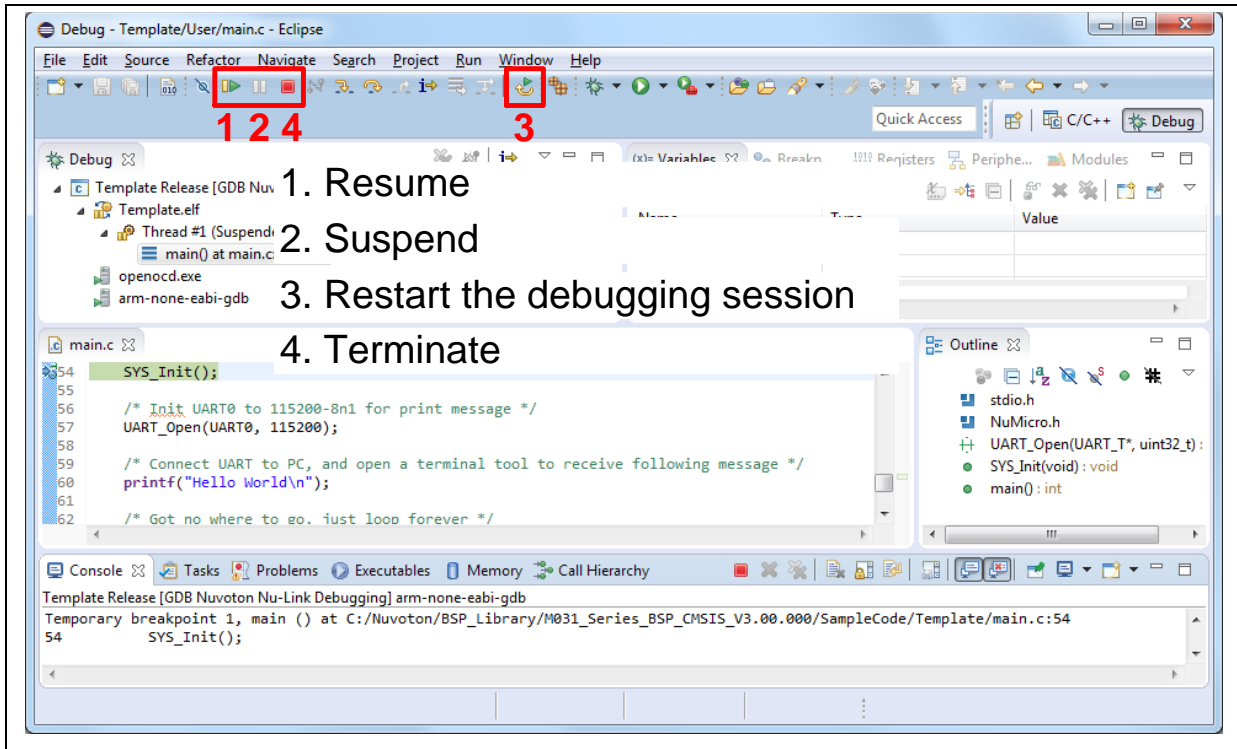

Figure 3-28 NuEclipse Debug Mode

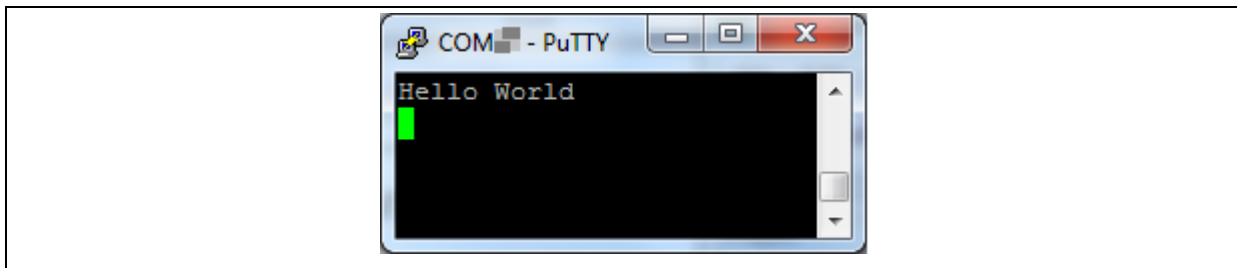

Figure 3-29 Debug Message on Serial Port Terminal Windows

## 4 NUMAKER-M032KI SCHEMATICS

### 4.1 Nu-Link2-Me

Figure 4-1 shows the Nu-Link2-Me circuit. The Nu-Link2-Me is a debugger and programmer that supports on-line programming and debugging through SWD interface.

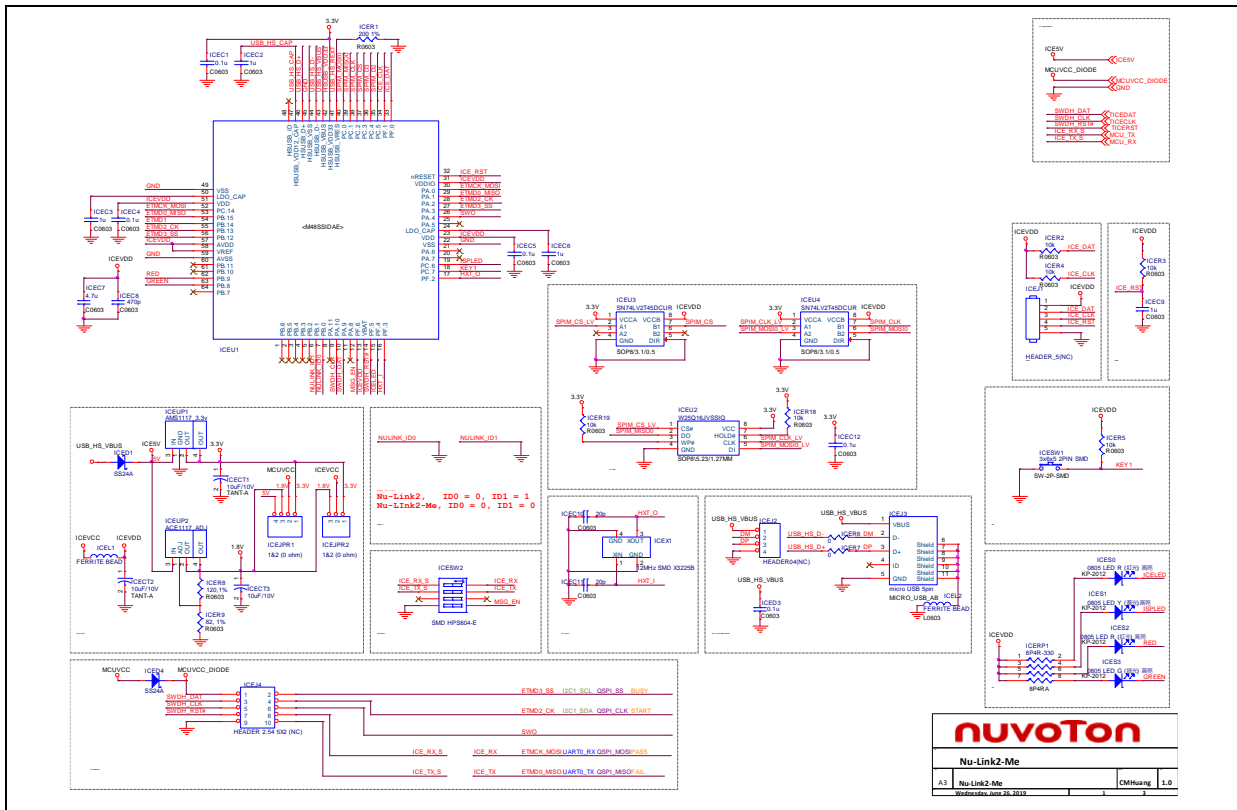

Figure 4-1 Nu-Link2-Me Circuit

### 4.2 M032 platform

Figure 4-2 shows the M032 platform circuit.

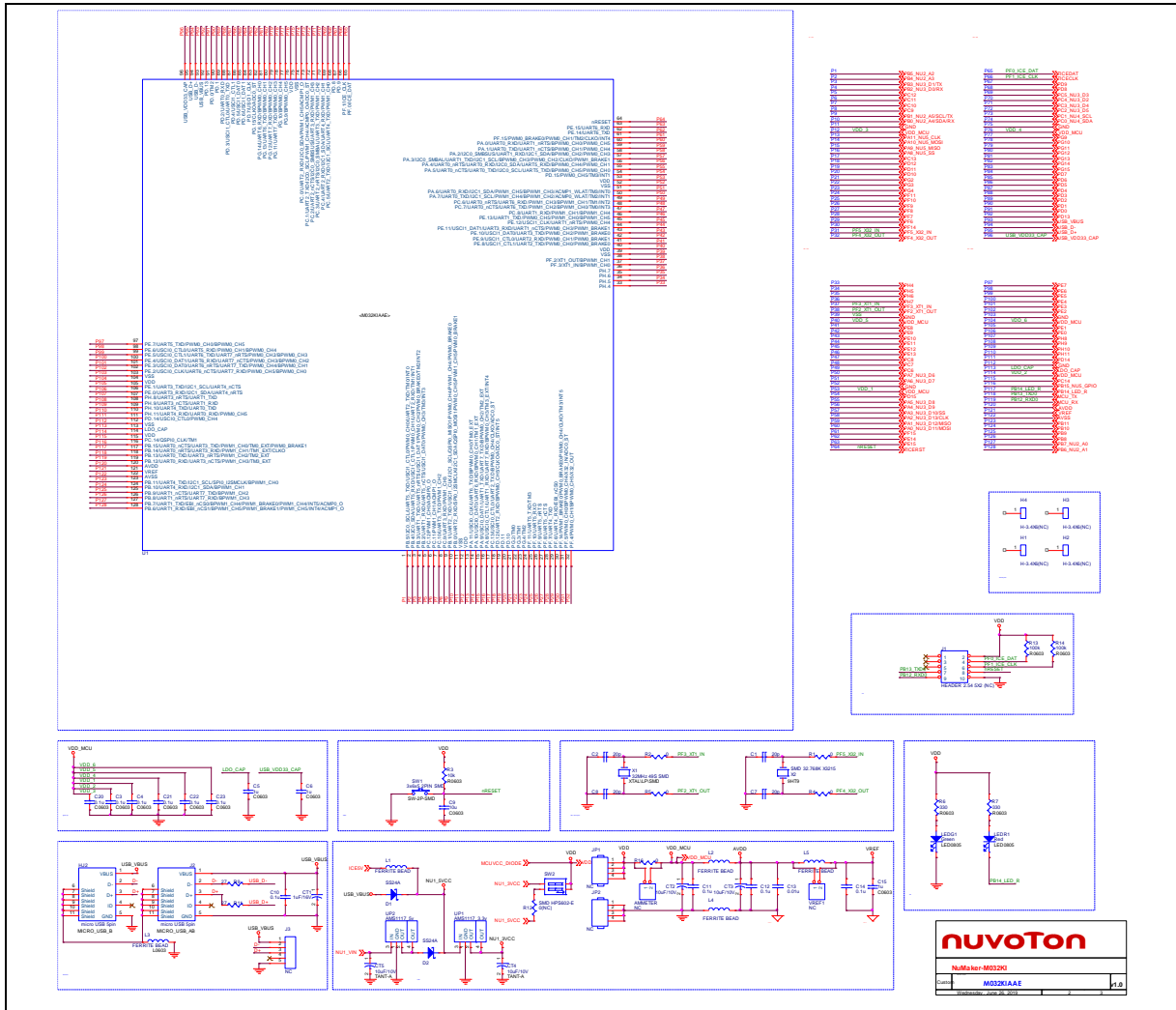

Figure 4-2 M032 platform Circuit

### 4.3 Extension Connector

Figure 4-3 shows extension connectors of NuMaker-M032KI.

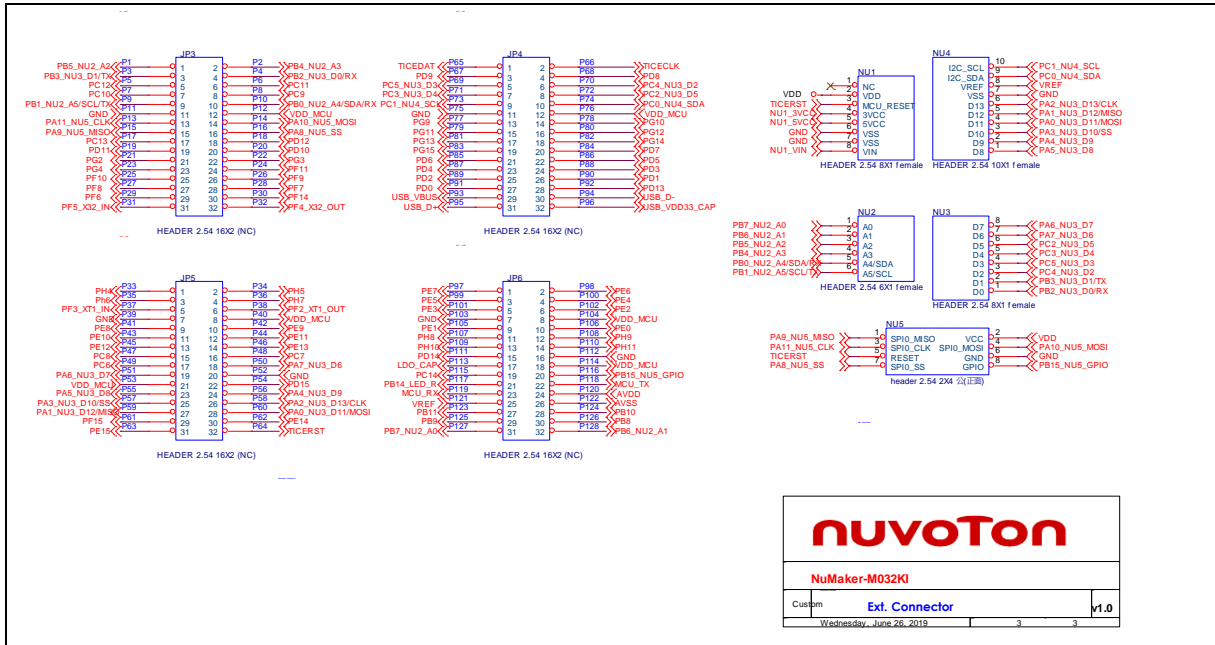

Figure 4-3 Extension Connectors Circuit

**5 REVISION HISTORY**

Date	Revision	Description
2019.09.24	1.00	1. Initially issued.

### Important Notice

Nuvoton Products are neither intended nor warranted for usage in systems or equipment, any malfunction or failure of which may cause loss of human life, bodily injury or severe property damage. Such applications are deemed, "Insecure Usage".

Insecure usage includes, but is not limited to: equipment for surgical implementation, atomic energy control instruments, airplane or spaceship instruments, the control or operation of dynamic, brake or safety systems designed for vehicular use, traffic signal instruments, all types of safety devices, and other applications intended to support or sustain life.

All Insecure Usage shall be made at customer's risk, and in the event that third parties lay claims to Nuvoton as a result of customer's Insecure Usage, customer shall indemnify the damages and liabilities thus incurred by Nuvoton.

---

*Please note that all data and specifications are subject to change without notice.  
All the trademarks of products and companies mentioned in this datasheet belong to their respective owners.*